



URB-Sicherungen

Sicherungseinsätze mit Schraubkontakten

URB Fuses

Fuse-links with screw contacts

Technische Daten nach Baureihen /
Technical Data Types of Fuses

Technische Daten Sicherungs-Unterteile /
Technical Data Fuse Bases

660 V

NH 000 / DIN 80

Verpackungseinheit / Packing unit: 6 Stück / 6 pieces

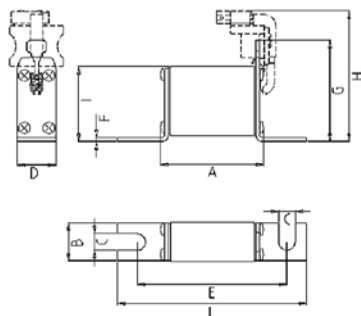

Betriebsklasse / Class gR/aR	IEC 60 269-4 VDE 0636-4
---------------------------------	----------------------------

Artikel Nr. Article No.	Größe Size	Länge Length										
		In/A	A	B	C	D	E	F	G	H	I	L
		A	mm	mm	mm	mm	mm	mm	mm	mm	mm	mm
20 282 04	NH000/DIN80	16-160	55	20	8,5	20,5	78	2	-	70	39	100
20 558 04		16-160	55	28,8	10,3	29,5	78	2,5	-	80	39	105

Bemessungsausschaltvermögen / Rated breaking capacity 100 kA

Bemessungsstrom Rated Current	Artikel Nr. Article No.		Gewicht Weight	Charakteristik Class	Bemessungs- spannung Rated Voltage	Schmelz- integral Pre-Arcing- I ² t-Value	Ausschalt- integral Total I ² t-Value	Leistungs- abgabe Power Loss
	mit Kennmelder with indicator	für ext. Meldeschal- ter/ for ext. switch*						
	A							
16	20 282 04:16	20 558 04:16	0,14	gR	660	10	70	5,0
20	20 282 04:20	20 558 04:20	0,14	gR	660	17	120	6,0
25	20 282 04:25	20 558 04:25	0,14	gR	660	29	200	7,0
32	20 282 04:32	20 558 04:32	0,14	gR	660	66	450	9,0
35	20 282 04:35	20 558 04:35	0,14	gR	660	81	550	9,0
40	20 282 04:40	20 558 04:40	0,14	gR	660	103	700	10
50	20 282 04:50	20 558 04:50	0,14	gR	660	184	1.300	11
63	20 282 04:63	20 558 04:63	0,14	gR	660	330	2.300	13
80	20 282 04:80	20 558 04:80	0,14	gR	660	512	3.500	18
100	20 282 04:100	20 558 04:100	0,14	gR	660	930	6.400	22
125	20 282 04:125	20 558 04:125	0,14	aR	660	1.650	11.200	24
160	20 282 04:160	20 558 04:160	0,14	aR	660	4.250	29.000	28

* Optional: GL-Meldeschal-ter siehe Seiten 45-46
GL-switch see pages 45-46

Sicherungshalter siehe Seite 42
Fuse-holder see page 42

Applikationskoeffizienten / Application coefficients (Weiterführende Informationen siehe Seite 13 / for more information see page 13)

a	A2	B1 max.	B2	Cf3
130	0,8	1,25	0,8	0,8

660 V

NH 000 / DIN 80

Zeit/Strom-Kennlinien
Time-current characteristics

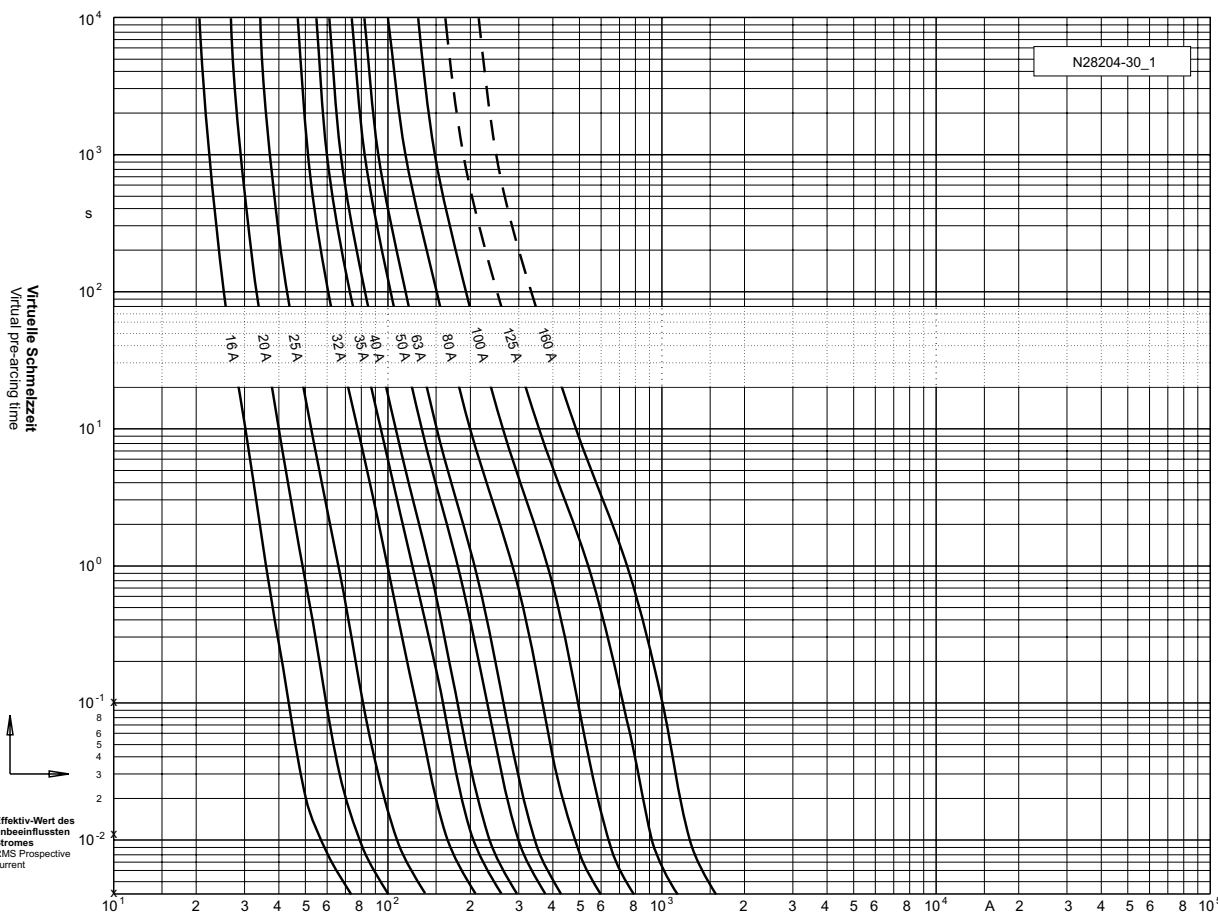

Durchlass-Strom
Cut-off current

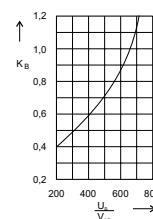
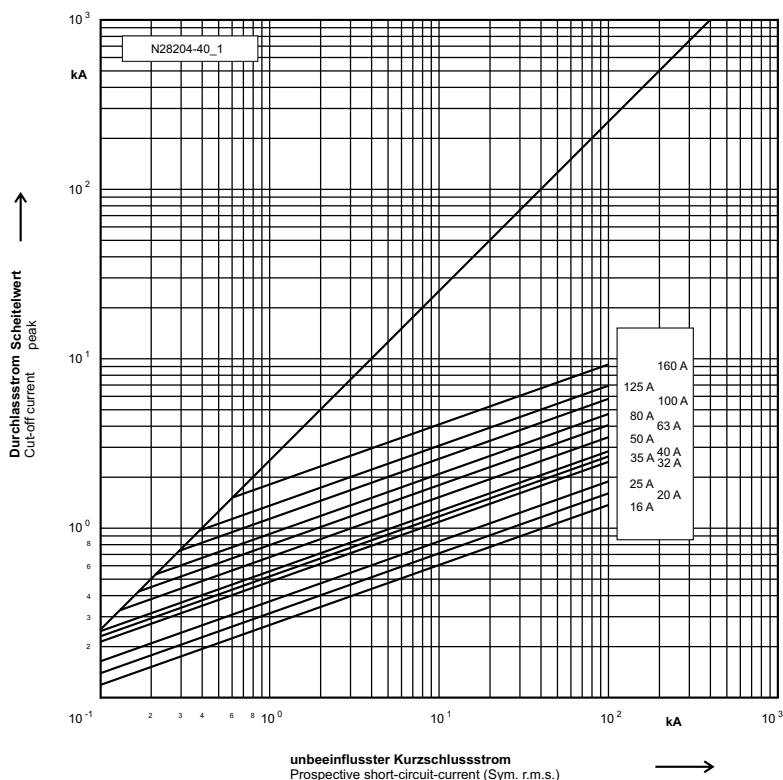

Umrechnungsfaktor für den Ausschalt i^2t -Wert
Reduction factor for total i^2t -value

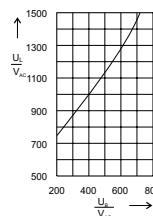

Schaltspannungsdiagramm
Arc Voltage-Diagram

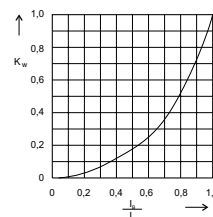

Umrechnungsfaktor der Leistungsabgabe
Reduction factor for power Loss

660 V

NH 00 / DIN 80

Verpackungseinheit / Packing unit: 3 Stück / 3 pieces

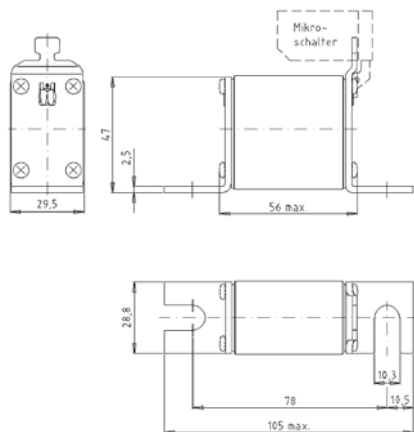

Betriebsklasse / Class gR/aR	IEC 60 269-4 VDE 0636-4
---------------------------------	----------------------------

Bemessungs- spannung Rated Voltage	Artikel Nr. Article No	Größe Size	Bemessungsstrom Rated Current
V			A
660	20 189 04	NH 00	16-250
	20 412 04		

Bemessungsausschaltvermögen / Rated breaking capacity 100 kA

Bemessungsstrom Rated Current	Artikel Nr. Article No.		Gewicht Weight	Charakteristik Class	Bemessungs- spannung Rated Voltage	Schmelz- integral Pre-Arcing- I ² t-Value	Ausschalt- integral Total I ² t-Value	Leistungs- abgabe Power Loss
	mit Kennmelder with indicator	für ext. Meldeschal- ter/ for ext. switch*						
A			kg / 1		V	A ² s	A ² s	W
16	20 189 04.16	20 412 04.16	0,2	gR	660	10	70	4,6
20	20 189 04.20	20 412 04.20	0,2	gR	660	17	120	5,5
25	20 189 04.25	20 412 04.25	0,2	gR	660	29	200	6,7
32	20 189 04.32	20 412 04.32	0,2	gR	660	66	450	8,9
35	20 189 04.35	20 412 04.35	0,2	gR	660	81	550	9,2
40	20 189 04.40	20 412 04.40	0,2	gR	660	103	700	9,8
50	20 189 04.50	20 412 04.50	0,2	gR	660	184	1.300	11
63	20 189 04.63	20 412 04.63	0,2	gR	660	330	2.300	13
80	20 189 04.80	20 412 04.80	0,2	gR	660	512	3.500	15
100	20 189 04.100	20 412 04.100	0,2	gR	660	930	6.400	18
125	20 189 04.125	20 412 04.125	0,2	aR	660	1.650	11.200	22
160	20 189 04.160	20 412 04.160	0,2	aR	660	4.250	29.000	26
200	20 189 04.200	20 412 04.200	0,2	aR	660	8.000	54.400	28
250	20 189 04.250	20 412 04.250	0,2	aR	660	16.800	114.300	31

* Optional: GL-Meldeschal-ter siehe Seiten 45-46
GL-switch see pages 45-46

Sicherungshalter siehe Seite 42
Fuse-holder see page 42

Applikationskoeffizienten / Application coefficients (Weiterführende Informationen siehe Seite 13 / for more information see page 13)

a	A2	B1 max.	B2	Cf3
130	0,8	1,25	0,8	0,8

660 V

NH 00 / DIN 80

Zeit/Strom-Kennlinien
Time-current characteristics

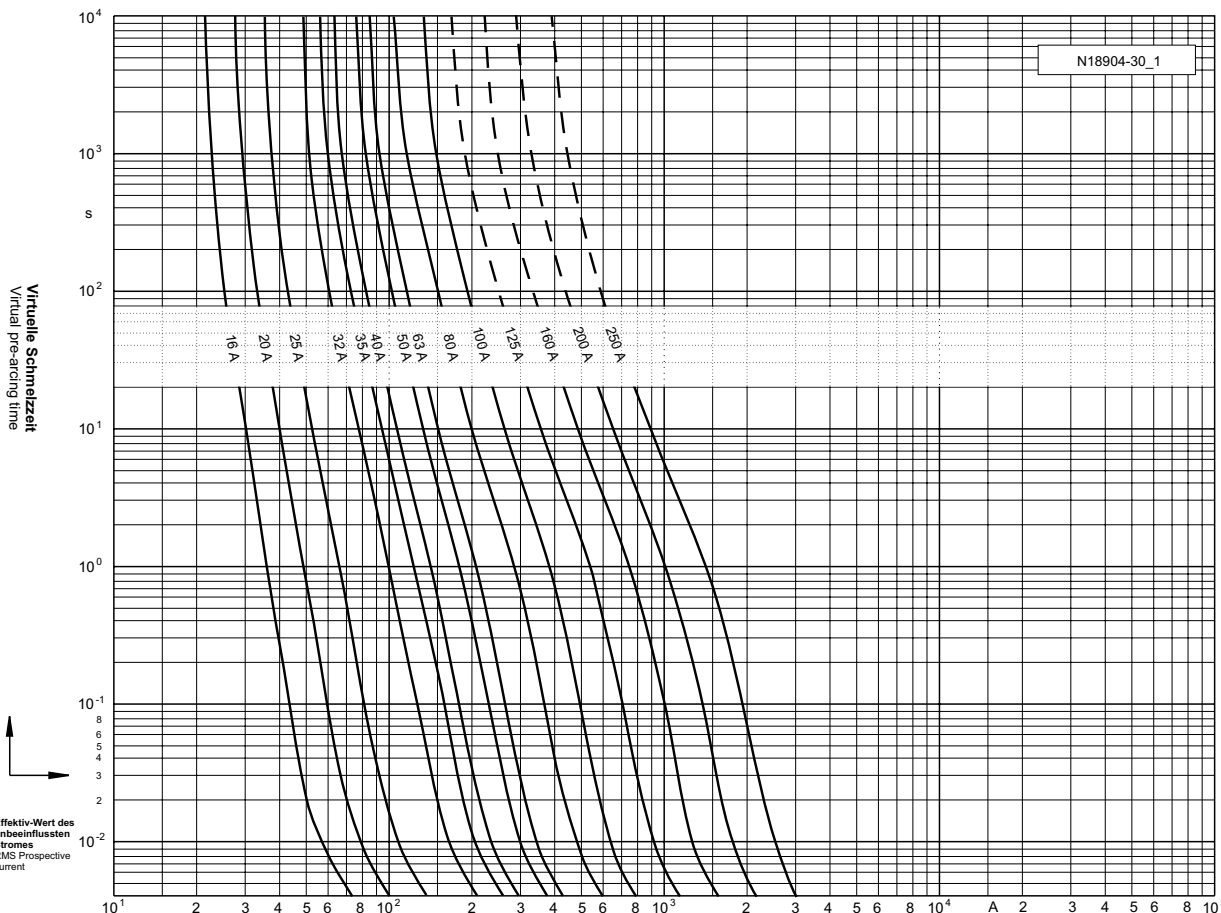

Durchlass-Strom
Cut-off current

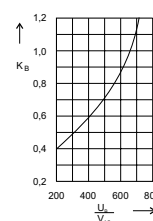
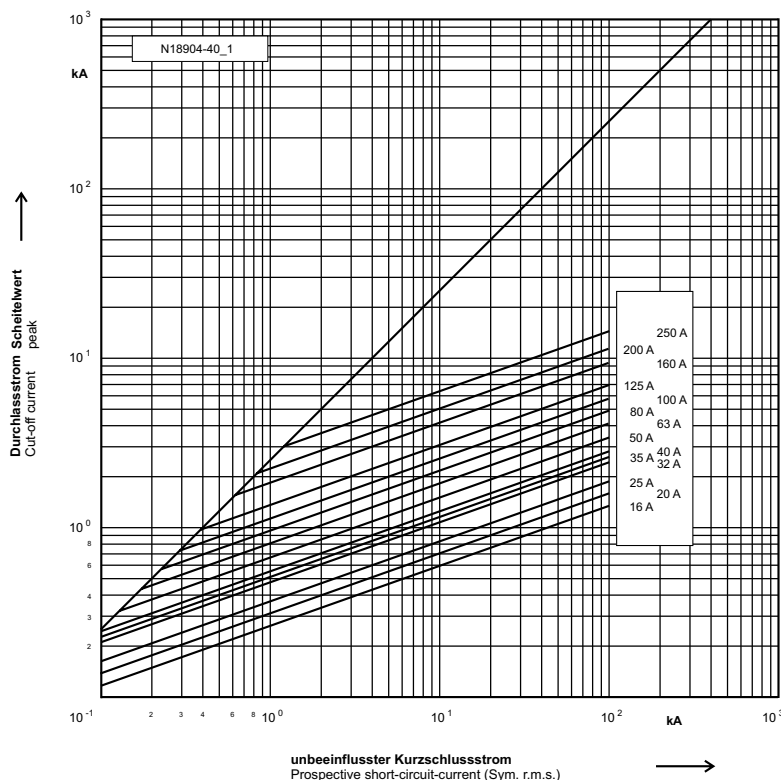

Umrechnungsfaktor für den Ausschalt i^2t -Wert
Reduction factor for total I^2t -value

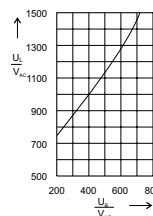

Schaltspannungsdiagramm
Arc Voltage-Diagram

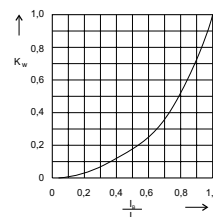

Umrechnungsfaktor der Leistungsabgabe
Reduction factor for power Loss

690 V

NH 000 - 00 / DIN 80

 us E180276

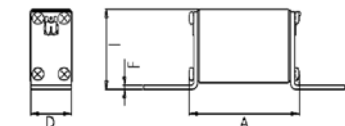

20 282 34
20 189 34

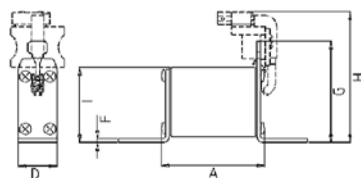
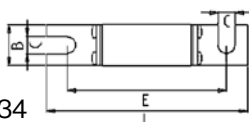

20 558 34
20 412 34

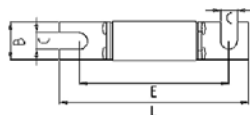

Verpackungseinheit / Packing unit: 6 Stück / 6 pieces

Betriebsklasse / Class gRL (gS)	IEC 60 269-4 VDE 0636-4 UL 248-13
------------------------------------	---

Bemessungsspannung Rated Voltage	Anzeiger Indicator	Griffflaschen Brackets	Mögl. GL-Meldeschalter suitable GL-switch
V			
690	Klappmelder flap indicator	-	-

Artikel Nr. Article No.	Größe Size	Länge Length										
		In/A	A	B	C	D	E	F	G	H	I	L
		A	mm	mm	mm	mm	mm	mm	mm	mm	mm	mm
20 282 34	NH000/DIN80	16-80	55	20	8,5	20,5	78	2	-	70	39	100
20 558 34*												
20 189 34	NH00/DIN80	100-200		28,8	10,3	29,5		2,5		80	48	105
20 412 34*												

Bemessungsausschaltvermögen / Rated breaking capacity **200 kA AC 700 V**

Bemessungsstrom Rated Current	Artikel Nr. Article No.		Gewicht Weight	Bemessungs- spannung Rated Voltage		Schmelzintegral Pre-Arcing I ² t-Value	Ausschalt- integral Total I ² t-Value	Leistungs- abgabe Power Loss
	mit Klappmelder with indicator	für ext. Meldeschalter/ for ext. switch*		IEC	UL			
				60269-4	248-13			
A			kg / 1	V	V	A ² s	A ² s	W
16	20 282 34.16	20 558 34.16	0,14	690	700	18	180	3,2
20	20 282 34.20	20 558 34.20	0,14	690	700	41	410	3,6
25	20 282 34.25	20 558 34.25	0,14	690	700	74	740	4,2
35	20 282 34.35	20 558 34.35	0,14	690	700	170	1.700	5,2
40	20 282 34.40	20 558 34.40	0,14	690	700	300	3.000	5,6
50	20 282 34.50	20 558 34.50	0,14	690	700	460	4.600	6,5
63	20 282 34.63	20 558 34.63	0,14	690	700	840	8.400	7,6
80	20 282 34.80	20 558 34.80	0,14	690	700	1.800	18.000	8,8
100	20 189 34.100	20 412 34.100	0,14	690	700	3.000	30.000	10,5
125	20 189 34.125	20 412 34.125	0,14	690	700	6.000	60.000	12
160	20 189 34.160	20 412 34.160	0,14	690	700	10.400	80.000	17
200	20 189 34.200	20 412 34.200	0,14	690	700	16.000	110.000	21

* Optional: GL-Meldeschalter siehe Seiten 45-46
GL-switch see pages 45-46

Sicherungshalter siehe Seite 42
Fuse-holder see page 42

Applikationskoeffizienten / Application coefficients (Weiterführende Informationen siehe Seite 13 / for more information see page 13)

a	A2	B1 max.	B2	Cf3
130	1,0	1,25	0,5	0,8

690 V

NH 000 - 00 / DIN 80

RU usE180276

Zeit/Strom-
Kennlinien
Time-current
characteristics

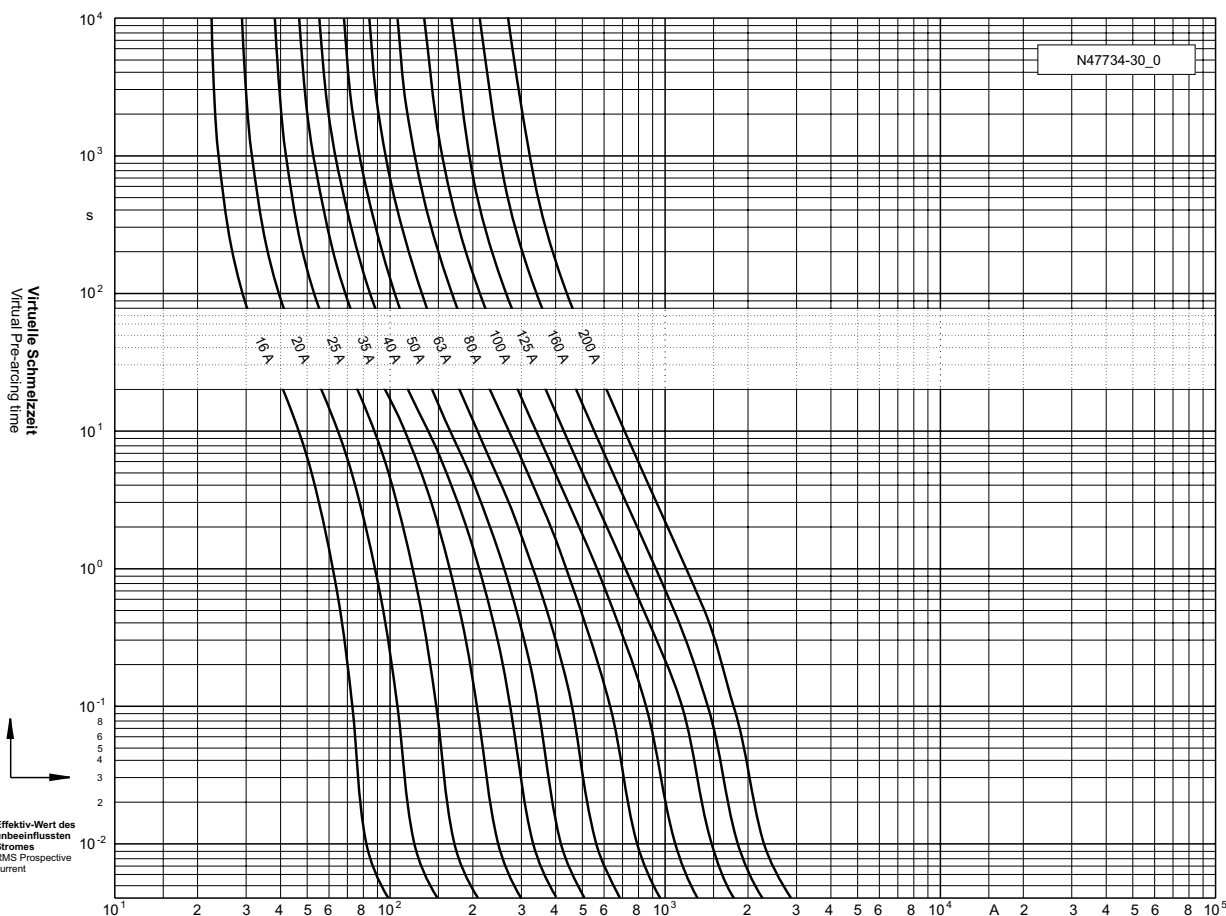

Durchlass-Strom
Cut-off current

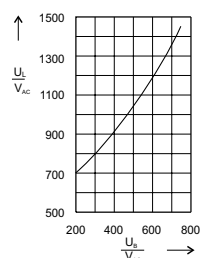
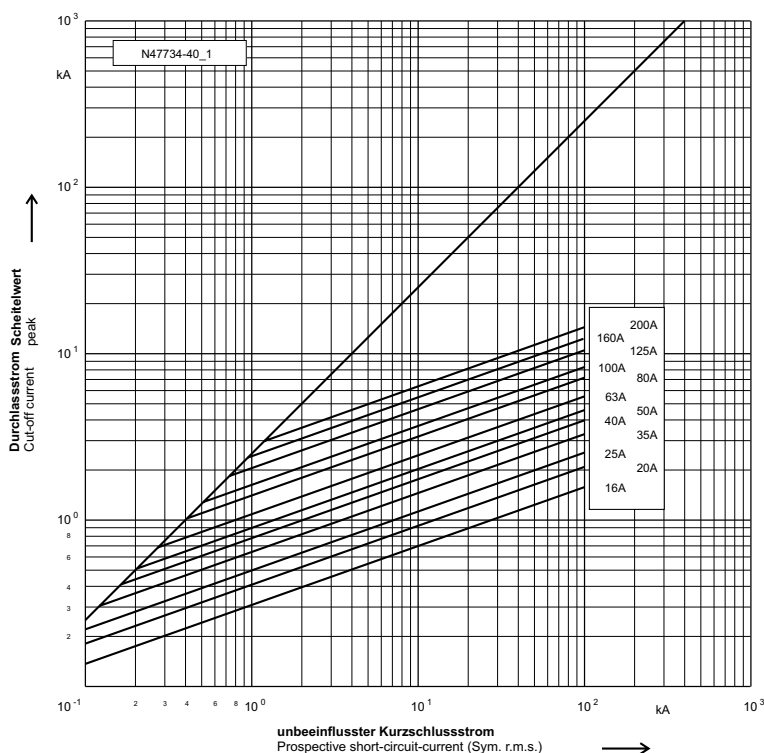

Umrechnungsfaktor für den
Ausschalt i^2t -Wert
Reduction factor for total i^2t -value

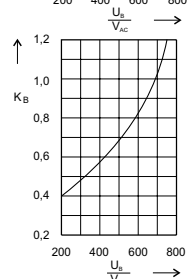

Schaltspannungsdiagramm
Arc Voltage-Diagram

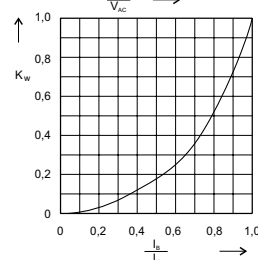

Umrechnungsfaktor der Leistungsabgabe
Reduction factor for power Loss

690 V

NH 00 / DIN 110

 us E180276

Verpackungseinheit / Packing unit: 3 Stück / 3 pieces

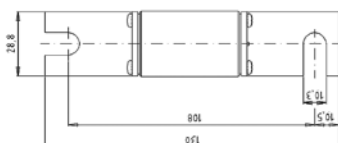
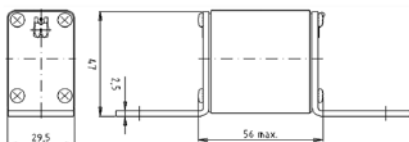

Betriebsklasse / Class
aR

IEC 60 269-4
VDE 0636-4
UL 248-13

Bemessungs- spannung Rated Voltage	Artikel Nr. Article No	Größe Size	Bemessungsstrom Rated Current
V			A
690	20 566 20	NH 00	35-400

Bemessungsausschaltvermögen / Rated breaking capacity 200 kA @ 700 V

Bemessungsstrom Rated Current	ArtikelNr. Article No.	Gewicht Weight	Bemessungsspannung Rated Voltage		Schmelzintegral Pre-Arcing- I ² t-Value	Ausschaltintegral Total I ² t-Value @ AC 660 V		Leistungs- abgabe Power Loss
			IEC 60269-4	UL 248-13		A ² s	A ² s	
			V	V		A ² s	W	
35	20 566 20.35	0.26	690	700	66	360	8	
40	20 566 20.40	0.26	690	700	90	500	10	
50	20 566 20.50	0.26	690	700	140	770	12	
63	20 566 20.63	0.26	690	700	250	1400	14	
80	20 566 20.80	0.26	690	700	470	2600	17	
100	20 566 20.100	0.26	690	700	730	4.000	21	
125	20 566 20.125	0.26	690	700	1.300	7.200	25	
160	20 566 20.160	0.26	690	700	2.800	15.400	31	
180	20 566 20.180	0.26	690	700	4.200	23.100	34	
200	20 566 20.200	0.26	690	700	5.000	27.500	37	
250	20 566 20.250	0.26	690	700	8.500	46.800	44	
315	20 566 20.315	0.26	690	700	15.600	86.000	53	
350	20 566 20.350	0.26	690	700	20.000	110.000	57	
400	20 566 20.400	0.26	690	700	28.400	156.000	68	

Sicherungshalter siehe Seite 42
Fuse-holder see page 42

Applikationskoeffizienten / Application coefficients (Weiterführende Informationen siehe Seite 13 / for more information see page 13)

a	A2	B1 max.	B2	Cf3
130	06	125	06	08

690 V

NH 00 / DIN 110

c **RU** us E180276

Zeit/Strom-
Kennlinien
Time-current
characteristics

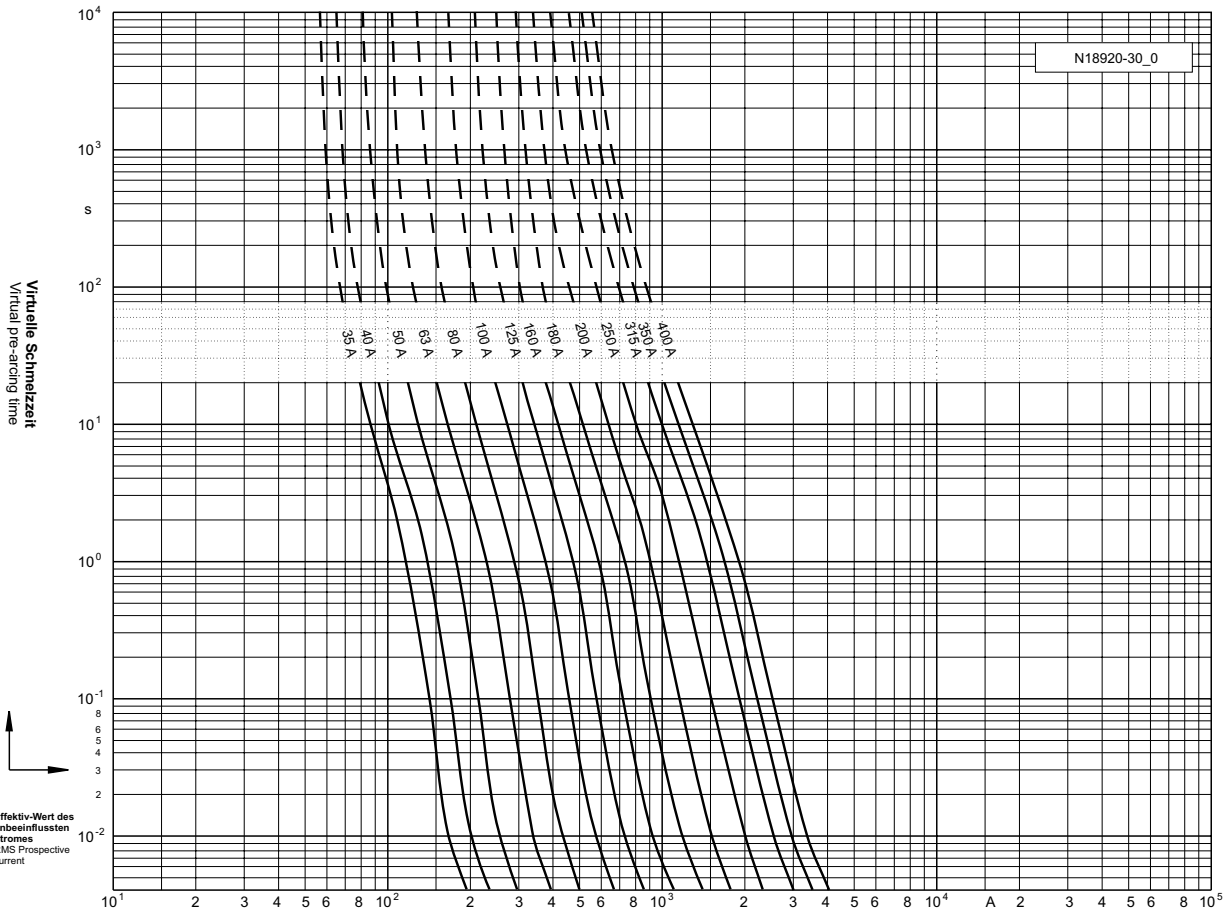

Durchlass-Strom
Cut-off current

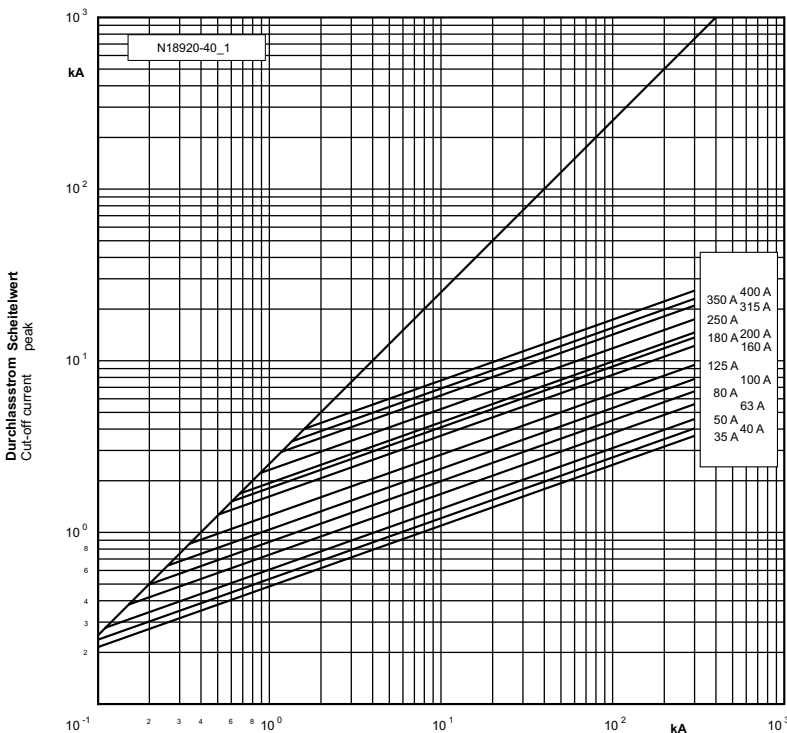

unbeeinflusster Kurzschlussstrom
Prospective short-circuit-current (Sym. r.m.s.)

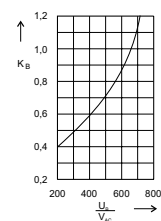

Umrechnungsfaktor
für den
Ausschalt i^2t -Wert
Reduction factor
for total I^2t -value

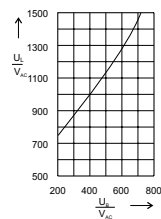

Schaltspannungs-
diagramm
Arc Voltage-Diagram

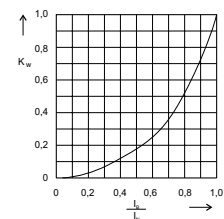

Umrechnungsfaktor
der
Leistungsabgabe
Reduction factor
for power Loss

690/700 V NH 000 / DIN 80

 us E180276

Verpackungseinheit / Packing unit: 6 Stück / 6 pieces

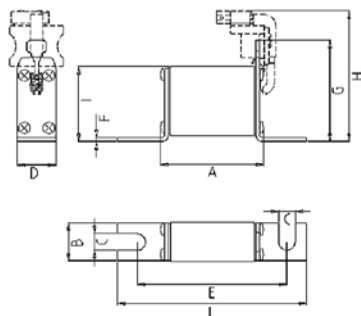

Betriebsklasse / Class aR	IEC 60 269-4 VDE 0636-4 UL 248-13
-------------------------------------	---

Artikel Nr. Article No.	Größe Size	Länge Length										
		In/A	A	B	C	D	E	F	G	H	I	L
		A	mm	mm	mm	mm	mm	mm	mm	mm	mm	mm
20 282 20	NH000/DIN80	32-400	55	20	8,5	20,5	78	2	-	-	39	100
20 558 20*		32-400		20	8,5	20,5		2	53	80		100

Bemessungsausschaltvermögen / Rated breaking capacity 200 kA @ 700 V

Bemessungsstrom Rated Current	Artikel Nr. Article No.		Gewicht Weight	Bemessungs- spannung Rated Voltage		Schmelz- integral Pre-Arcing- I ² t-Value	Ausschalt- integral Total I ² t-Value @ AC 660 V	Leistungs- abgabe Power Loss
	mit Kennmelder with indicator	für ext. Meldeschal- ter/ for ext. switch*		IEC 60269- 4	UL 248-13			
	A			kg / 1	V			
32	20 282 20.32	20 558 20.32	0,14	690	700	52	290	8
35	20 282 20.35	20 558 20.35	0,14	690	700	66	360	9
40	20 282 20.40	20 558 20.40	0,14	690	700	90	500	10
50	20 282 20.50	20 558 20.50	0,14	690	700	140	770	12
63	20 282 20.63	20 558 20.63	0,14	690	700	250	1400	14
80	20 282 20.80	20 558 20.80	0,14	690	700	470	2600	18
100	20 282 20.100	20 558 20.100	0,14	690	700	730	4000	22
110	20 282 20.110	20 558 20.110	0,14	690	700	890	4900	24
125	20 282 20.125	20 558 20.125	0,14	690	700	1.300	7.200	26
150	20 282 20.150	20 558 20.150	0,14	690	700	2.000	11.000	29
160	20 282 20.160	20 558 20.160	0,14	690	700	2.800	15.400	32
180	20 282 20.180	20 558 20.180	0,14	690	700	3.700	20.400	35
200	20 282 20.200	20 558 20.200	0,14	690	700	4.500	25.000	39
225	20 282 20.225	20 558 20.225	0,14	690	700	6.600	37.000	44
250	20 282 20.250	20 558 20.250	0,14	690	700	8.000	44.000	47
315	20 282 20.315	20 558 20.315	0,14	690	700	14.000	77.000	58
350	20 282 20.350	20 558 20.350	0,14	500	-	23.800	(@ AC 550 V) 76.000	56
400	20 282 20.400	20 558 20.400	0,14	500	-	32.100	(@ AC 550 V) 106.000	70

* Optional: GL-Meldeschal-
ter siehe Seiten 45-46
GL-switch see pages 45-46

Sicherungshalter siehe Seite 42
Fuse-holder see page 42

Applikationskoeffizienten / Application coefficients (Weiterführende Informationen siehe Seite 13 / for more information see page 13)

a	A2	B1 max.	B2	Cf3
130	06	125	06	08

690/700 V NH 000 / DIN 80

cULus E180276

Zeit/Strom-Kennlinien
Time-current characteristics

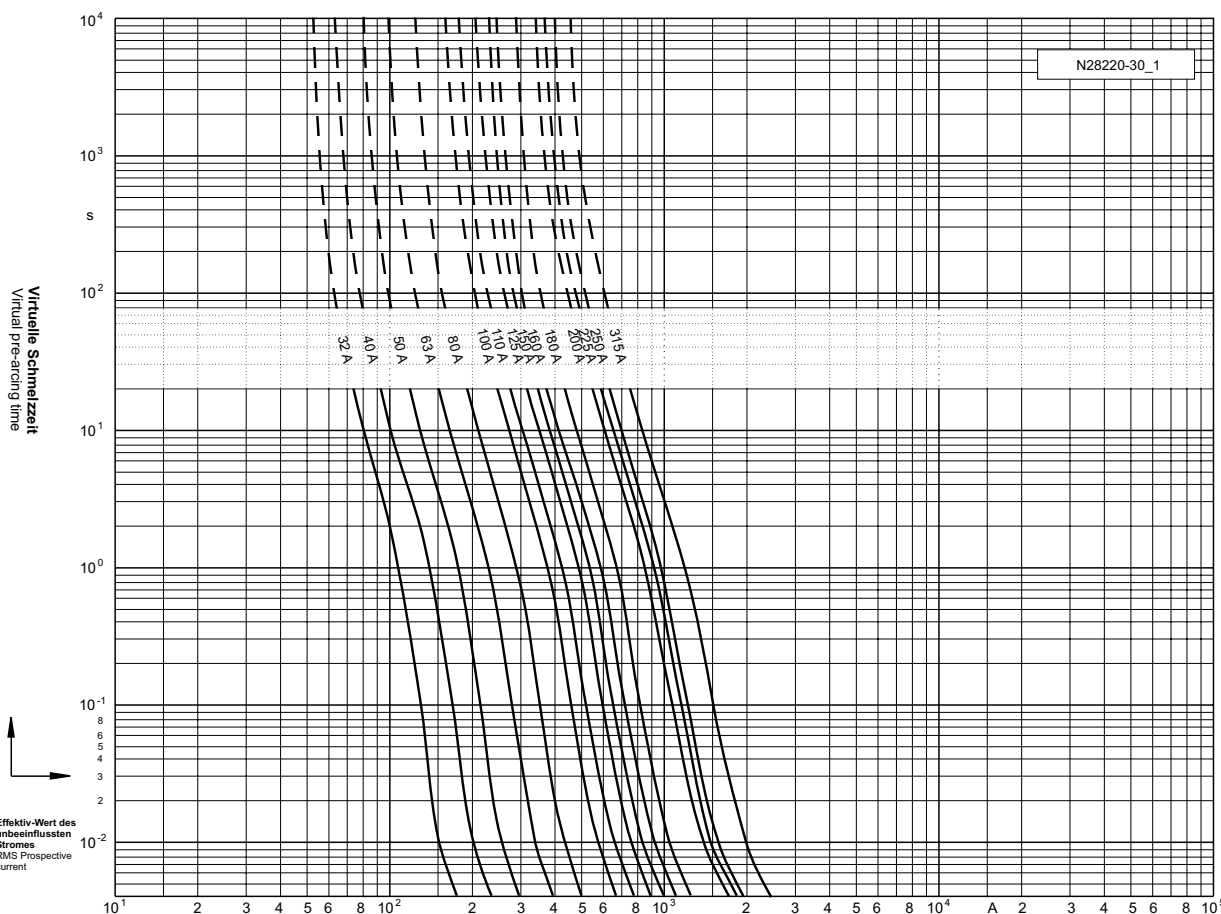

Durchlass-Strom
Cut-off current

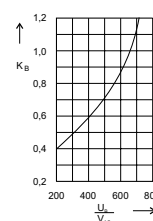
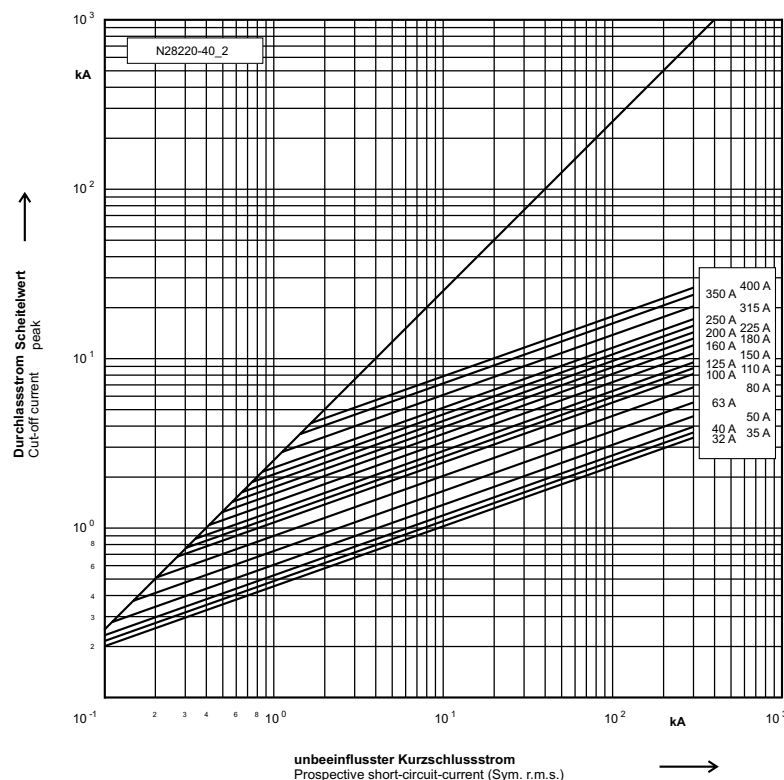

Umrechnungsfaktor für den Ausschalt i^2t -Wert
Reduction factor for total I^2t -value

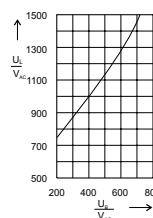

Schaltspannungsdiagramm
Arc Voltage-Diagram

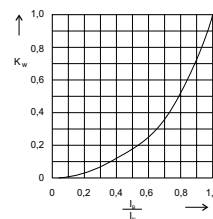

Umrechnungsfaktor der Leistungsabgabe
Reduction factor for power Loss

690/700 V NH 000 BS 70

us E180276

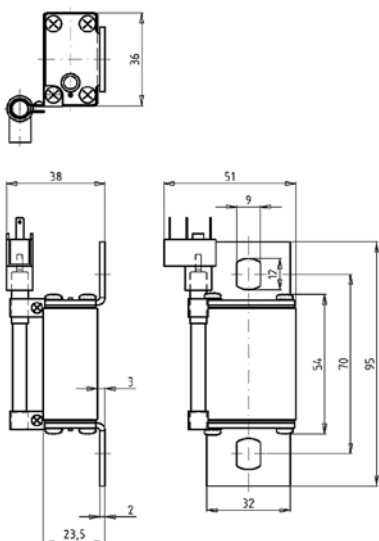

Verpackungseinheit / Packing unit: 6/3 Stück / 6/3 pieces

Betriebsklasse / Class aR	IEC 60 269-4 VDE 0636-4 UL 248-13
------------------------------	---

Bemessungs- spannung Rated Voltage	Artikel Nr. Article No	Größe Size	Bemessungsstrom Rated Current
V			A
690 / 700	20 559 20 20 559 22**	NH 000	32-400

** kein UL

Bemessungsausschaltvermögen / Rated breaking capacity 200 kA @ 700 V

Bemessungsstrom Rated Current	Artikel Nr. Article No.		Gewicht Weight	Bemessungs- spannung Rated Voltage		Schmelz- integral Pre-Arcing- I ² t-Value	Ausschalt- integral Total I ² t-Value @ AC 660 V	Leistungs- abgabe Power Loss
	mit Kennmelder with indicator	für ext. Meldeschal- ter/ for ext. switch*		IEC 60269-4	UL 248-13			
	A			kg / 1	V			
32	20 559 20.32	20 559 22.32	0,14	690	700	52	290	8
35	20 559 20.35	20 559 22.35	0,14	690	700	66	360	9
40	20 559 20.40	20 559 22.40	0,14	690	700	90	500	10
50	20 559 20.50	20 559 22.50	0,14	690	700	140	770	12
63	20 559 20.63	20 559 22.63	0,14	690	700	250	1400	14
80	20 559 20.80	20 559 22.80	0,14	690	700	470	2600	18
100	20 559 20.100	20 559 22.100	0,14	690	700	730	4000	22
110	20 559 20.110	20 559 22.110	0,14	690	700	890	4900	24
125	20 559 20.125	20 559 22.125	0,14	690	700	1300	7200	26
150	20 559 20.150	20 559 22.150	0,14	690	700	2.000	11.000	29
160	20 559 20.160	20 559 22.160	0,14	690	700	2.800	15.400	32
180	20 559 20.180	20 559 22.180	0,14	690	700	3.700	20.400	35
200	20 559 20.200	20 559 22.200	0,14	690	700	4.500	25.000	39
225	20 559 20.225	20 559 22.225	0,14	690	700	6.600	37.000	44
250	20 559 20.250	20 559 22.250	0,14	690	700	8.000	44.000	47
315	20 559 20.315	20 559 22.315	0,14	690	700	14.000	77.000	58
350	20 559 20.350	20 559 22.350	0,14	500	-	23.800	(@ AC 550 V) 76.000	56
400	20 559 20.400	20 559 22.400	0,14	500	-	32.100	(@ AC 550 V) 106.000	70

Sicherungshalter siehe Seite 42
Fuse-holder see page 42

Applikationskoeffizienten / Application coefficients (Weiterführende Informationen siehe Seite 13 / for more information see page 13)

a	A2	B1 max.	B2	Cf3
130	06	1,25	0,6	08

690/700 V

NH 000 BS 70

c **RU** us E180276

Zeit/Strom-Kennlinien
Time-current characteristics

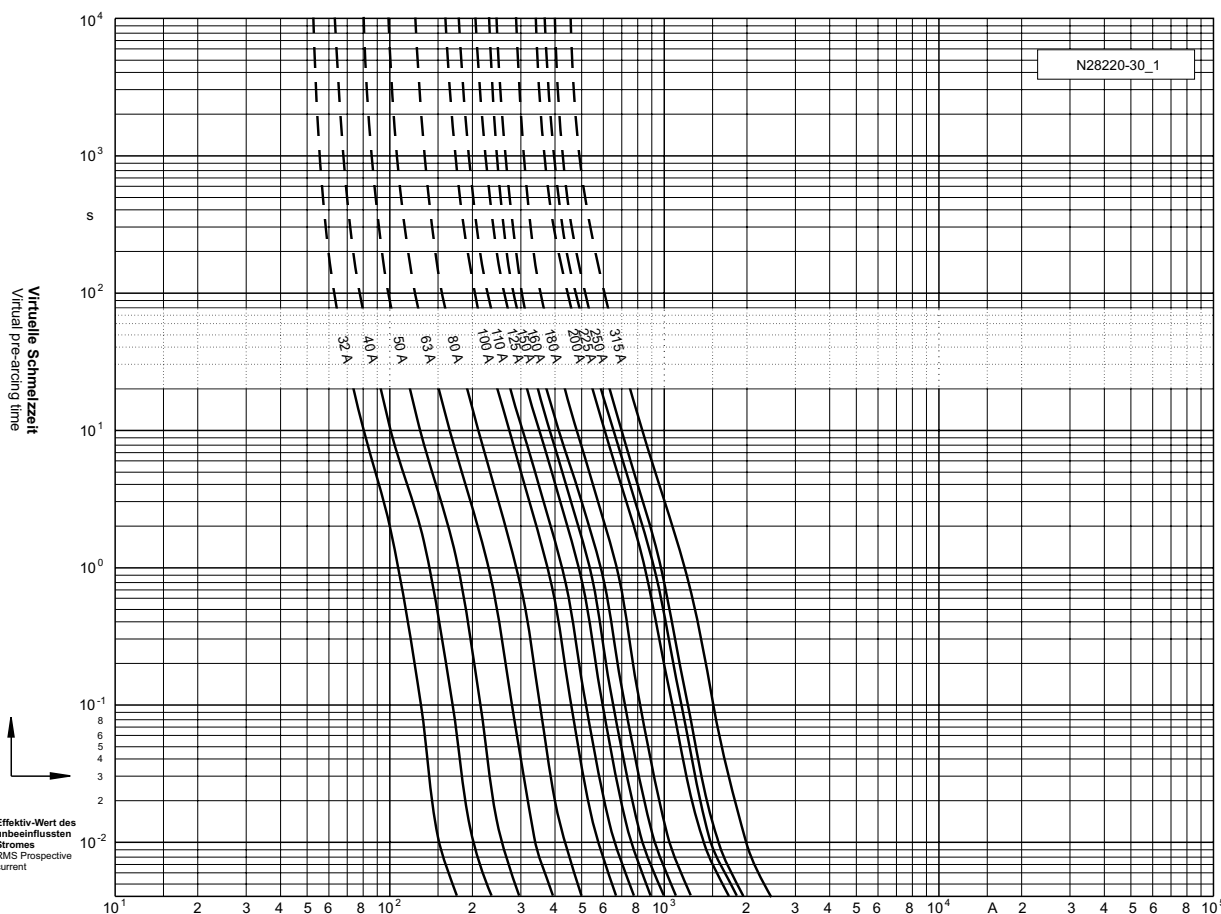

Durchlass-Strom
Cut-off current

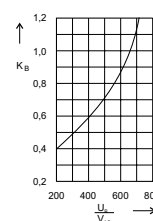
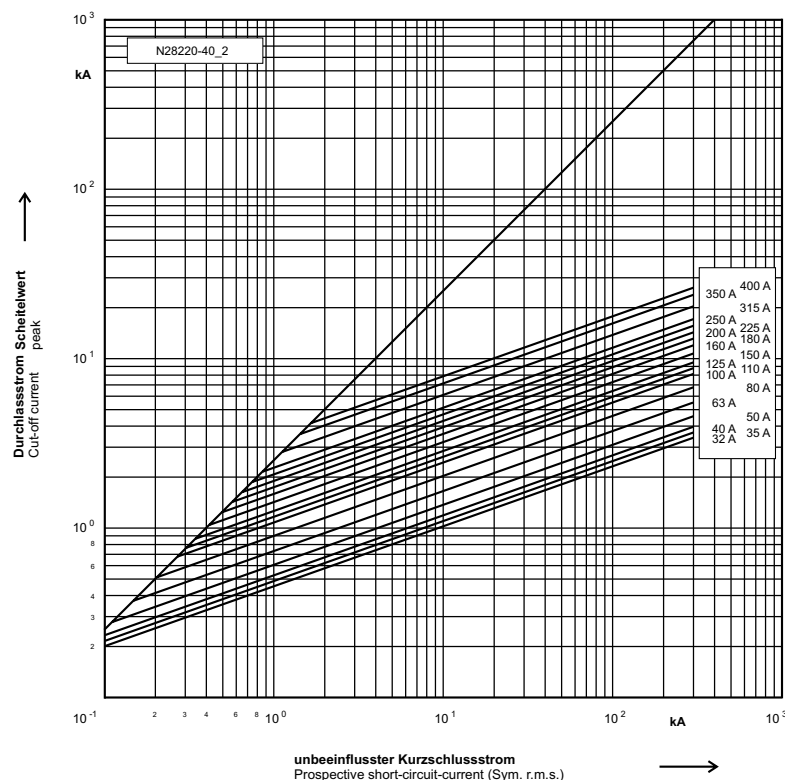

Umrechnungsfaktor für den Ausschalt i^2t -Wert
Reduction factor for total I^2t -value

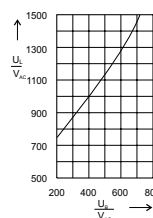

Schaltspannungsdiagramm
Arc Voltage-Diagram

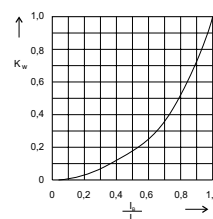

Umrechnungsfaktor der Leistungsabgabe
Reduction factor for power Loss

690/700 V NH 00 / DIN 80

 **usE180276**

Verpackungseinheit / Packing unit: 3 Stück / 3 pieces

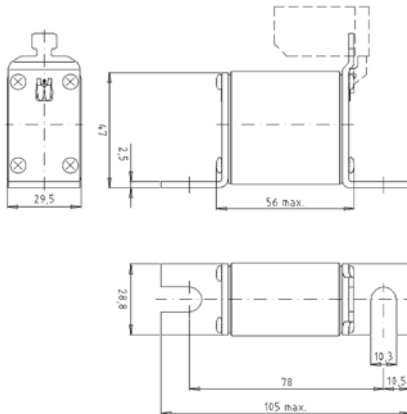

Betriebsklasse / Class
aR

**IEC 60 269-4
VDE 0636-4
UL 248-13**

Bemessungs- spannung Rated Voltage	Artikel Nr. Article No	Größe Size	Bemessungsstrom Rated Current
V			A
690	20 189 20 20 412 20	NH 00	35-400

Bemessungsausschaltvermögen / Rated breaking capacity 200 kA @ 700 V

Bemessungsstrom Rated Current	ArtikelNr. Article No.		Gewicht Weight	Bemessungs- spannung Rated Voltage		Schmelz- integral Pre-Arcing- I ² t-Value	Ausschalt- integral Total I ² t-Value @ AC 660 V	Leistungs- abgabe Power Loss
	mit Kennmelder with indicator	für ext. Meldeschal- ter/ for ext. switch*		IEC 60269-4	UL 248-13			
	A			kg / 1	V			
35	20 189 20.35	20 412 20.35	0.2	690	700	66	360	8
40	20 189 20.40	20 412 20.40	0.2	690	700	90	500	10
50	20 189 20.50	20 412 20.50	0.2	690	700	140	770	12
63	20 189 20.63	20 412 20.63	0.2	690	700	250	1400	14
80	20 189 20.80	20 412 20.80	0.2	690	700	470	2600	17
100	20 189 20.100	20 412 20.100	0.2	690	700	730	4.000	21
125	20 189 20.125	20 412 20.125	0.2	690	700	1.300	7.200	25
160	20 189 20.160	20 412 20.160	0.2	690	700	2.800	15.400	31
180	20 189 20.180	20 412 20.180	0.2	690	700	4.200	23.100	34
200	20 189 20.200	20 412 20.200	0.2	690	700	5.000	27.500	37
250	20 189 20.250	20 412 20.250	0.2	690	700	8.500	46.800	44
315	20 189 20.315	20 412 20.315	0.2	690	700	15.600	86.000	53
350	20 189 20.350	20 412 20.350	0.2	690	700	20.000	110.000	57
400	20 189 20.400	20 412 20.400	0.2	690	700	28.400	156.000	68

* Optional: GL-Meldeschal-ter siehe Seiten 45-46
GL-switch see pages 45-46

Sicherungshalter siehe Seite 42
Fuse holder see page 40

Applikationskoeffizienten / Application coefficients (Weiterführende Informationen siehe Seite 13 / for more information see page 13)

a	A2	B1 max.	B2	Cf3
130	06	125	06	08

690/700 V NH 00 / DIN 80

c **RU** usE180276

Zeit/Strom-Kennlinien
Time-current characteristics

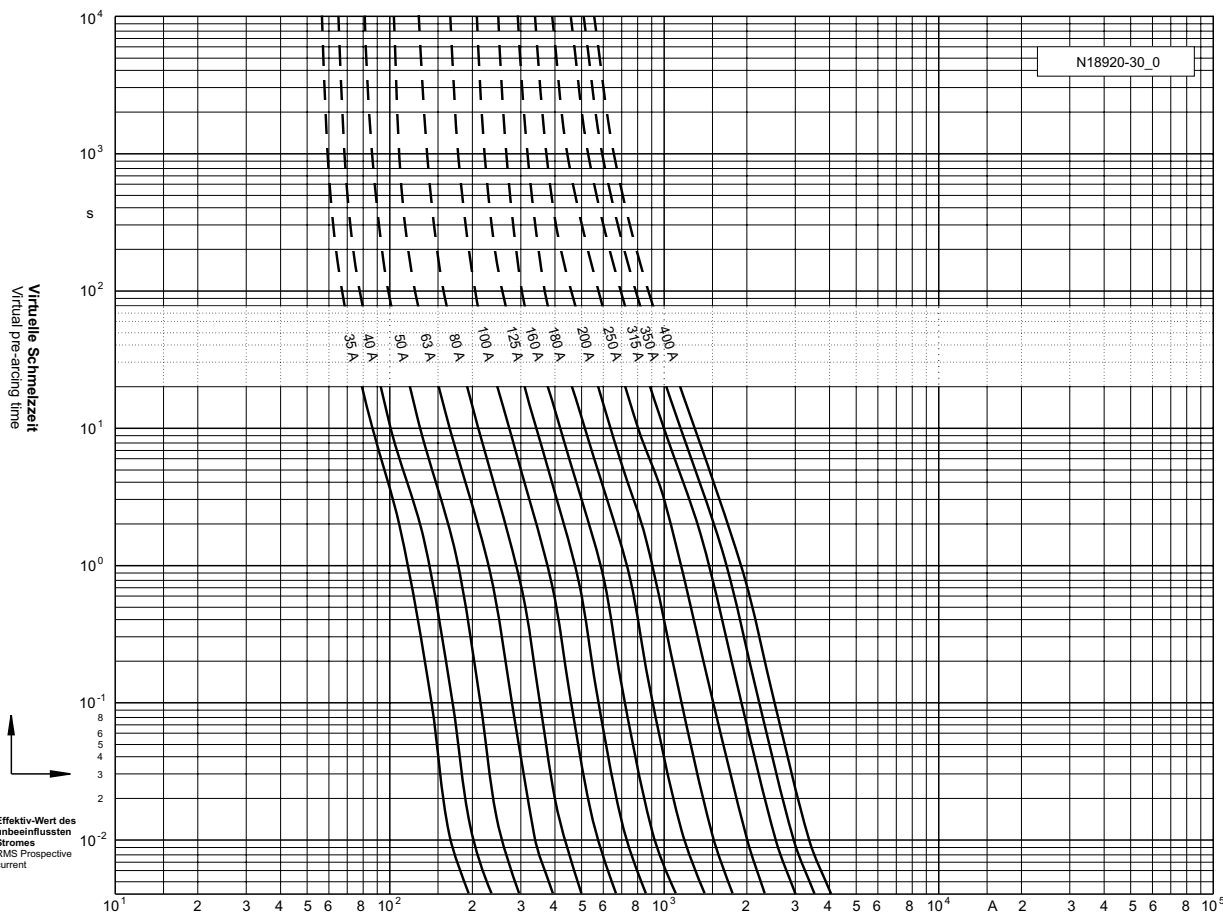

Durchlass-Strom
Cut-off current

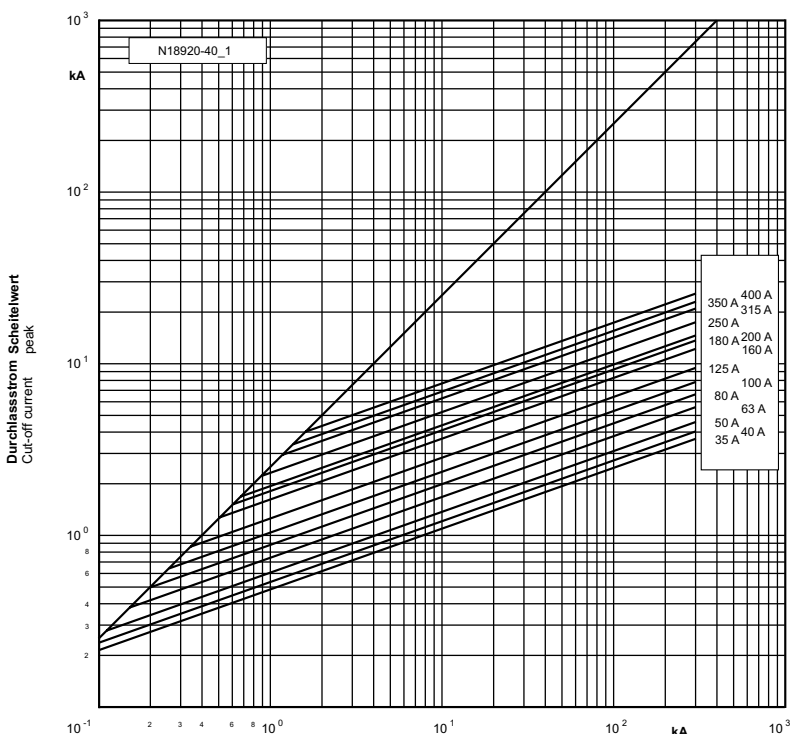

unbeeinflusster Kurzschlussstrom
Prospective short-circuit-current (Sym. r.m.s.)

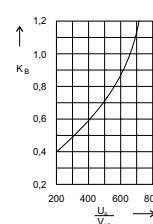

Umrechnungsfaktor für den Ausschalt i^2t -Wert
Reduction factor for total I^2t -value

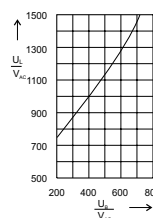

Schaltspannungsdiagramm
Arc Voltage-Diagram

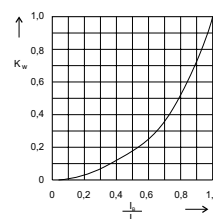

Umrechnungsfaktor der Leistungsabgabe
Reduction factor for power Loss

690 V

NH 000 BS 85

Verpackungseinheit / Packing unit: 6/3 Stück / 6/3 pieces

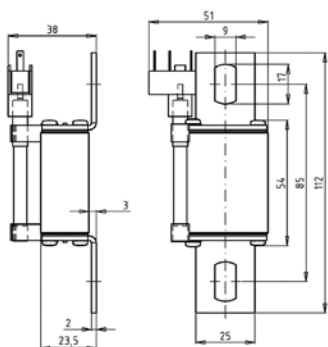
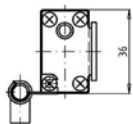

Betriebsklasse / Class aR	IEC 60 269-4 VDE 0636-4
------------------------------	----------------------------

Bemessungs- spannung Rated Voltage	Artikel Nr. Article No	Größe Size	Bemessungsstrom Rated Current
V			A
690	20 561 20	NH 000	110-400
	20 561 22*		

Bemessungsausschaltvermögen / Rated breaking capacity 120 kA

Bemessungsstrom Rated Current	Artikel Nr. Article No.		Gewicht Weight	Bemessungs- spannung Rated Voltage	Schmelz- integral Pre-Arcing- I ² t-Value	Ausschalt- integral Total I ² t-Value	Leistungs- abgabe Power Loss
	ohne Kennmelder without indicator	für ext. Meldeschalter/ for ext. switch*		IEC	@ AC 660 V		
	A			kg / l	V	A ² s	
110	20 561 20.110	20 561 22.110	0,16	690	1.350	6.000	21
125	20 561 20.125	20 561 22.125	0,16	690	2.000	8.900	22
150	20 561 20.150	20 561 22.150	0,16	690	3.300	14.000	24
160	20 561 20.160	20 561 22.160	0,16	690	3.700	16.000	27
180	20 561 20.180	20 561 22.180	0,16	690	5.400	23.000	30
200	20 561 20.200	20 561 22.200	0,16	690	11.200	47.000	31
250	20 561 20.250	20 561 22.250	0,16	690	14.900	63.000	32
280	20 561 20.280	20 561 22.280	0,16	690	17.000	70.000	44
315	20 561 20.315	20 561 22.315	0,16	690	19.200	77.000	50
350	20 561 20.350	20 561 22.350	0,16	500	23.800	76.000	56
400	20 561 20.400	20 561 22.400	0,16	500	32.100	101.000	70

Sicherungshalter siehe Seite 42
Fuse holder see page 40

Applikationskoeffizienten / Application coefficients (Weiterführende Informationen siehe Seite 13 / for more information see page 13)

a	A2	B1 max.	B2	Cf3
130	0,6	1,25	0,6	0,8

690 V

NH 000 BS 85

Zeit/Strom-Kennlinien
Time-current characteristics

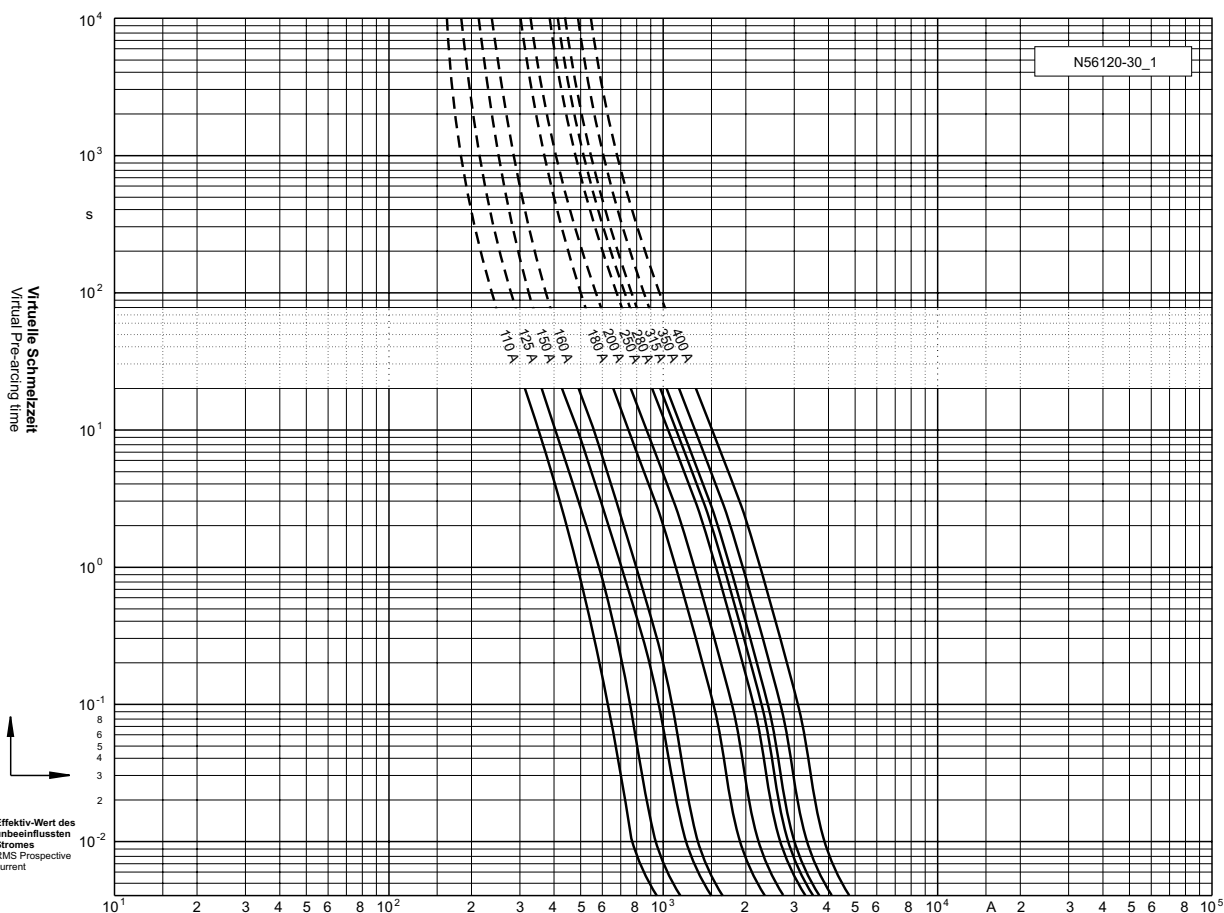

Durchlass-Strom
Cut-off current

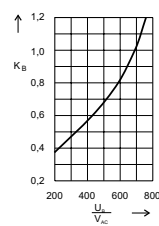
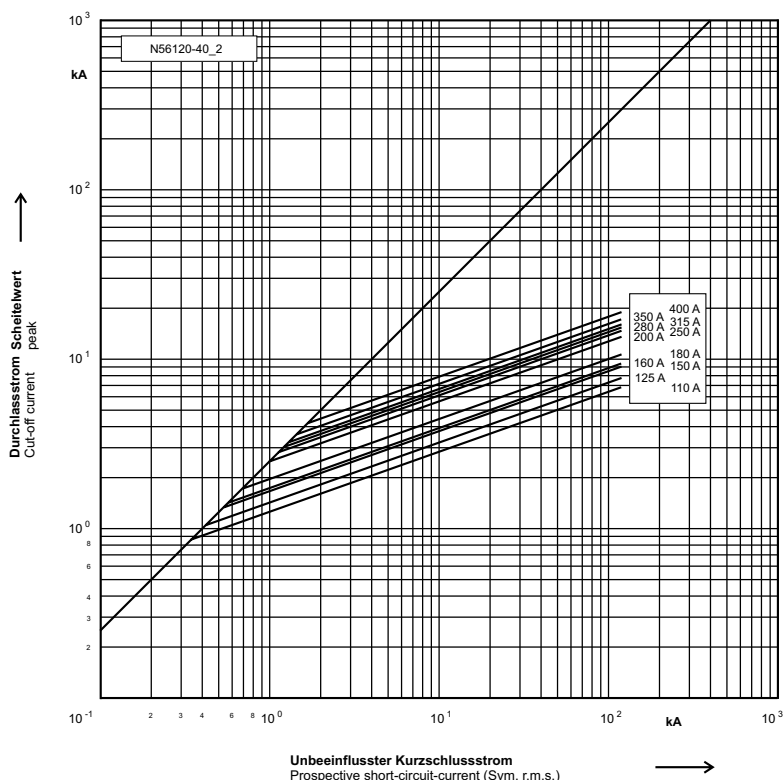

Umrechnungsfaktor für den Ausschalt i^2t -Wert
Reduction factor for total I^2t -value

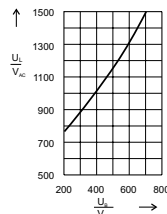

Schaltspannungsdiagramm
Arc Voltage-Diagram

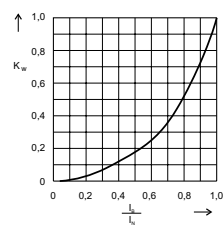

Umrechnungsfaktor der Leistungsabgabe
Reduction factor for power Loss

690 V

NH 000 BS 85

Verpackungseinheit / Packing unit: 3/2 Stück / 3/2 pieces

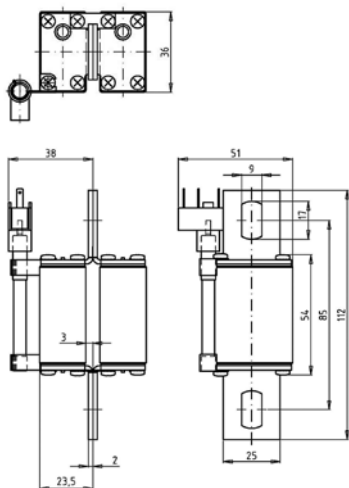

Betriebsklasse / Class aR	IEC 60 269-4 VDE 0636-4
-------------------------------------	----------------------------

Bemessungs- spannung Rated Voltage	Artikel Nr. Article No	Größe Size	Bemessungsstrom Rated Current
V			A
690	20 563 20 20 563 22*	2 x NH 000	400-800

Bemessungsausschaltvermögen / Rated breaking capacity 120 kA

Bemessungsstrom Rated Current	Artikel Nr. Article No.		Gewicht Weight	Bemessungs- spannung Rated Voltage	Schmelz- integral Pre-Arcing- I ² t-Value	Ausschalt- integral Total I ² t-Value	Leistungs- abgabe Power Loss
	ohne Kennmelder without indicator	für ext. Meldeschalter/ for ext. switch*		IEC	@ AC 690 V		
A			kg / 1	V	A ² s	A ² s	W
400	20 563 20.400	20 563 22.400	0,3	690	44.800	188.000	65
450	20 563 20.450	20 563 22.450	0,3	690	52.000	220.000	68
500	20 563 20.500	20 563 22.500	0,3	690	59.600	252.000	69
560	20 563 20.560	20 563 22.560	0,3	690	68.000	280.000	93
630	20 563 20.630	20 563 22.630	0,3	690	76.800	308.000	105
700	20 563 20.700	20 563 22.700	0,3	500	95.200	304.000	118
800	20 563 20.800	20 563 22.800	0,3	500	129.000	404.000	147

Sicherungshalter siehe Seite 42
Fuse holder see page 40

Applikationskoeffizienten / Application coefficients (Weiterführende Informationen siehe Seite 13 / for more information see page 13)

a	A2	B1 max.	B2	Cf3
130	06	1,25	0,6	08

690 V

NH 000 BS 85

Zeit/Strom-Kennlinien
Time-current characteristics

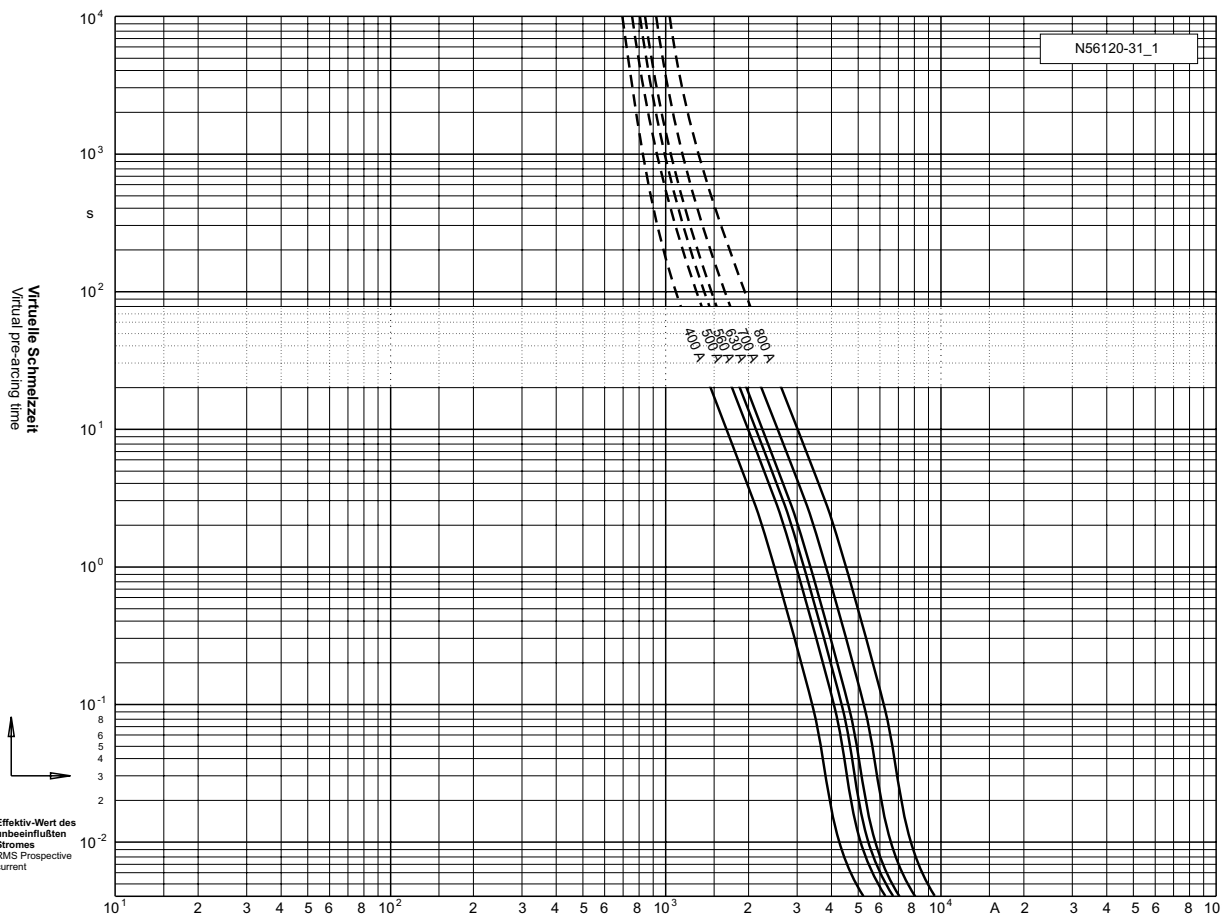

Durchlass-Strom
Cut-off current

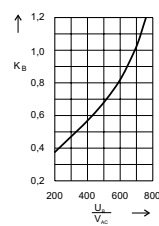
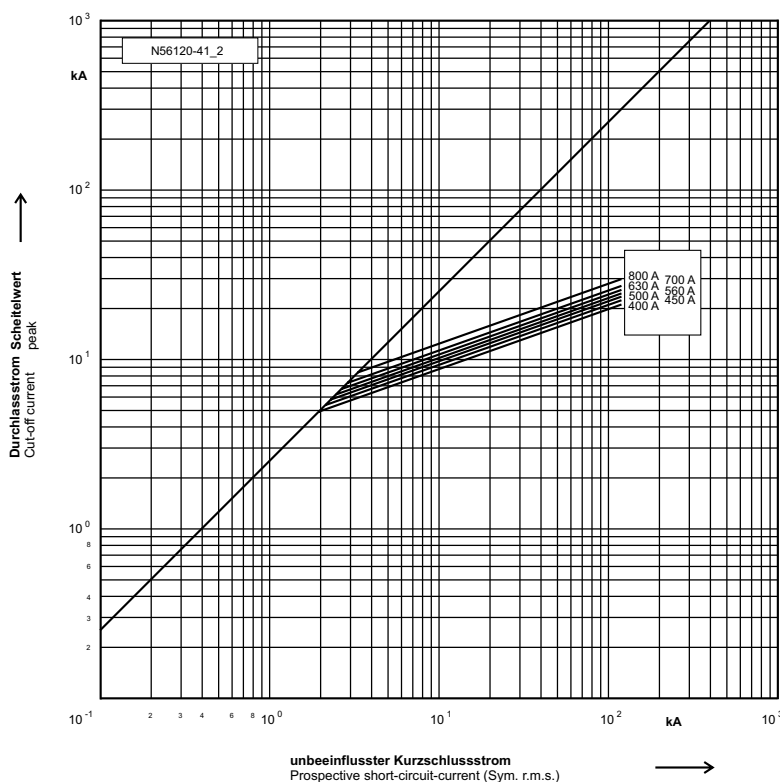

Umrechnungsfaktor für den Ausschalt i^2t -Wert
Reduction factor for total I^2t -value

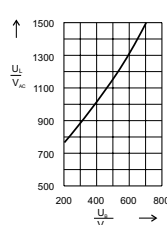

Schaltspannungsdiagramm
Arc Voltage-Diagram

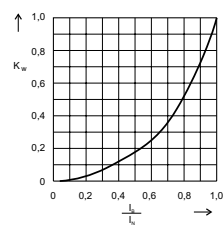

Umrechnungsfaktor der Leistungsabgabe
Reduction factor for power Loss

1000 V

NH 00 / DIN 80

Verpackungseinheit / Packing unit: 6 Stück / 6 pieces

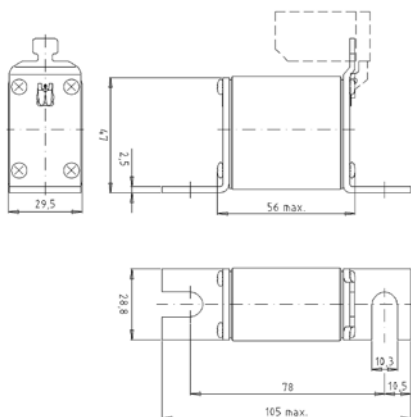

Betriebsklasse / Class aR	IEC 60 269-4 VDE 0636-4
------------------------------	----------------------------

Bemessungs- spannung Rated Voltage	Artikel Nr. Article No	Größe Size	Bemessungsstrom Rated Current
V			A
1000	20 560 20	NH 00	32-315
	20 562 20*		

Bemessungsausschaltvermögen / Rated breaking capacity 100 kA
Gleichspannungsschaltvermögen / DC Breaking Capacity 30 kA DC 750 V L/R = 4 ms
(current ratings ≤ 250 A)

Bemessungsstrom Rated Current	Artikel Nr. Article No.		Gewicht Weight	Bemessungs- spannung Rated Voltage	Schmelz- integral Pre-Arcing- I ² t-Value	Ausschaltintegral Total I ² t-Value @ AC 1000 V	Leistungs- abgabe Power Loss
	mit Kennmelder with indicator	für ext. Meldeschalter/ for ext. switch*					
A			kg / 1	V	A ² s	A ² s	W
32	20 560 20.32	20 562 20.32	0,2	1000	32	220	14
40	20 560 20.40	20 562 20.40	0,2	1000	56	400	16
50	20 560 20.50	20 562 20.50	0,2	1000	100	700	18
63	20 560 20.63	20 562 20.63	0,2	1000	180	1.200	22
80	20 560 20.80	20 562 20.80	0,2	1000	410	2.800	25
100	20 560 20.100	20 562 20.100	0,2	1000	740	5.000	28
125	20 560 20.125	20 562 20.125	0,2	1000	1.300	9.000	32
160	20 560 20.160	20 562 20.160	0,2	1000	2.600	17.500	40
200	20 560 20.200	20 562 20.200	0,2	1000	4.600	31.000	46
224	20 560 20.224	20 562 20.224	0,2	1000	5.600	38.000	48
250	20 560 20.250	20 562 20.250	0,2	1000	8.200	55.000	51
280	20 560 20.280	20 562 20.280	0,2	900	10.600	70.500	55
315	20 560 20.315	20 562 20.315	0,2	900	16.000	106.000	59

* Optional: GL-Meldeschalter siehe Seiten 45-46
GL-switch see pages 45-46

Sicherungshalter siehe Seite 42
Fuse-holder see page 42

Applikationskoeffizienten / Application coefficients (Weiterführende Informationen siehe Seite 13 / for more information see page 13)

a	A2	B1 max.	B2	Cf3
130	06	125	06	08

1000 V

NH 00 / DIN 80

Zeit/Strom-Kennlinien
Time-current characteristics

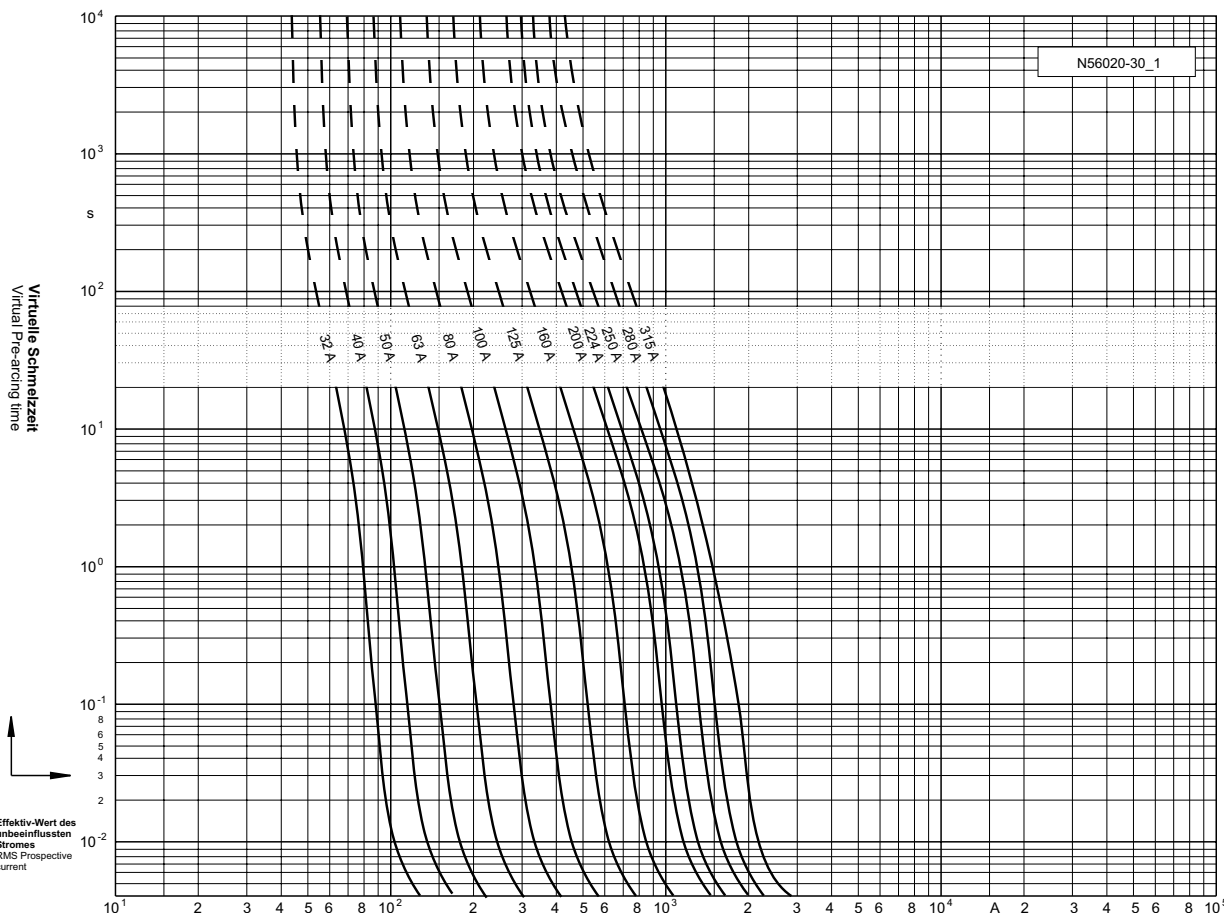

Durchlass-Strom
Cut-off current

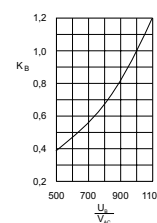
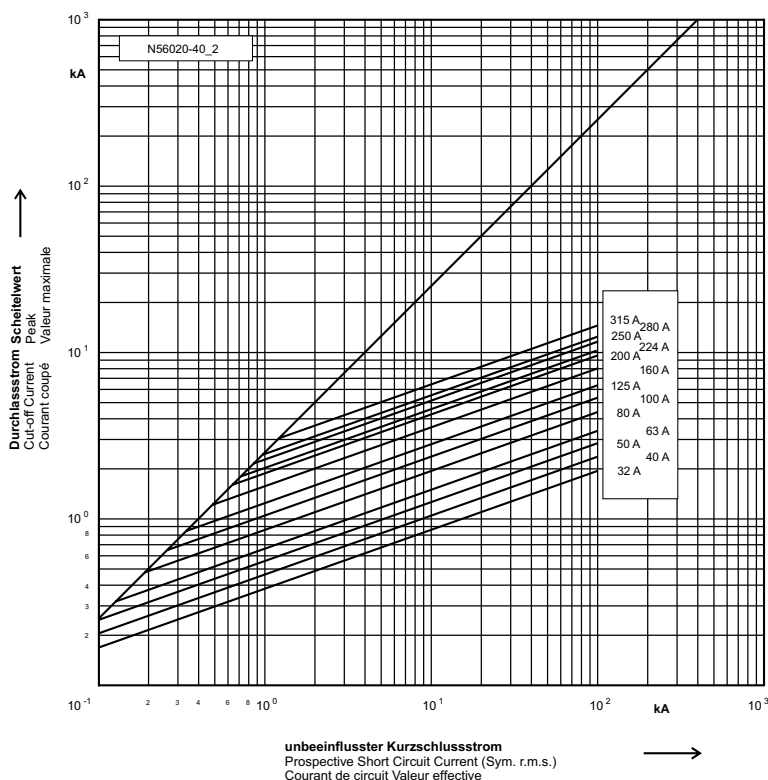

Umrechnungsfaktor für den Ausschalt i^2t -Wert
Reduction factor for total I^2t -value

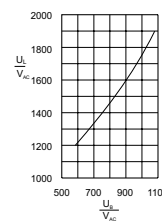

Schaltspannungsdiagramm
Arc Voltage-Diagram

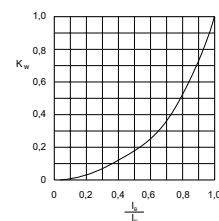

Umrechnungsfaktor der Leistungsabgabe
Reduction factor for power Loss

DC 600 V

NH 00 / DIN 80

Verpackungseinheit / Packing unit: 3 Stück / 3 pieces

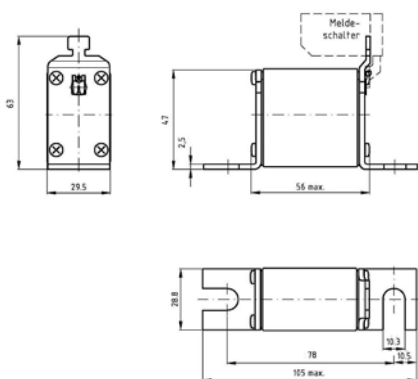

Betriebsklasse / Class gPV	IEC 60 269-6 VDE 0636-6 acc. UL 248-19
-------------------------------	--

Bemessungs- spannung Rated Voltage	Artikel Nr. Article No	Größe Size	Bemessungsstrom Rated Current
V			A
DC 600	20 189 28	NH 00	35-160
	20 189 29		
	20 412 29*		

Bemessungsausschaltvermögen / Rated breaking capacity 30 kA @ DC 600 V L/R=1-3 ms

Bemessungsstrom Rated Current	Artikel Nr. Article No.			Gewicht Weight	Bemessungs- spannung Rated Voltage	Schmelz- integral Pre-Arcing- I ² t-Value	Ausschalt- integral Total I ² t-Value @ DC 600 V	Leistungs- abgabe Power Loss
	ohne Kennmelder without indicator	mit Kennmelder with indicator	für ext. Meldeshalter/ for ext. switch*					
	A							
35	20 189 28.35	20 189 29.35	20 412 29.35	0,2	DC 600	62	380	7,3
40	20 189 28.40	20 189 29.40	20 412 29.40	0,2	DC 600	105	630	7,5
50	20 189 28.50	20 189 29.50	20 412 29.50	0,2	DC 600	160	960	11,0
63	20 189 28.63	20 189 29.63	20 412 29.63	0,2	DC 600	250	1.500	12,5
70	20 189 28.70	20 189 29.70	20 412 29.70	0,2	DC 600	415	2.500	13,0
80	20 189 28.80	20 189 29.80	20 412 29.80	0,2	DC 600	520	3.200	14,0
100	20 189 28.100	20 189 29.100	20 412 29.100	0,2	DC 600	1.000	6.000	15,5
110	20 189 28.110	20 189 29.110	20 412 29.110	0,2	DC 600	1.300	7.900	17,5
125	20 189 28.125	20 189 29.125	20 412 29.125	0,2	DC 600	1.650	10.000	20,0
160	20 189 28.160	20 189 29.160	20 412 29.160	0,2	DC 600	4.000	24.000	21,5

* Optional: GL-Meldeshalter siehe Seiten 45-46
GL-switch see pages 45-46

Sicherungshalter siehe Seite 42
Fuse-holder see page 42

Applikationskoeffizienten / Application coefficients (Weiterführende Informationen siehe Seite 13 / for more information see page 13)

a	A2	B1 max.	B2	Cf3
130	0,8	1,25	0,5	0,8

DC 600 V

NH 00 / DIN 80

Zeit/Strom-
Kennlinien
Time-current
characteristics

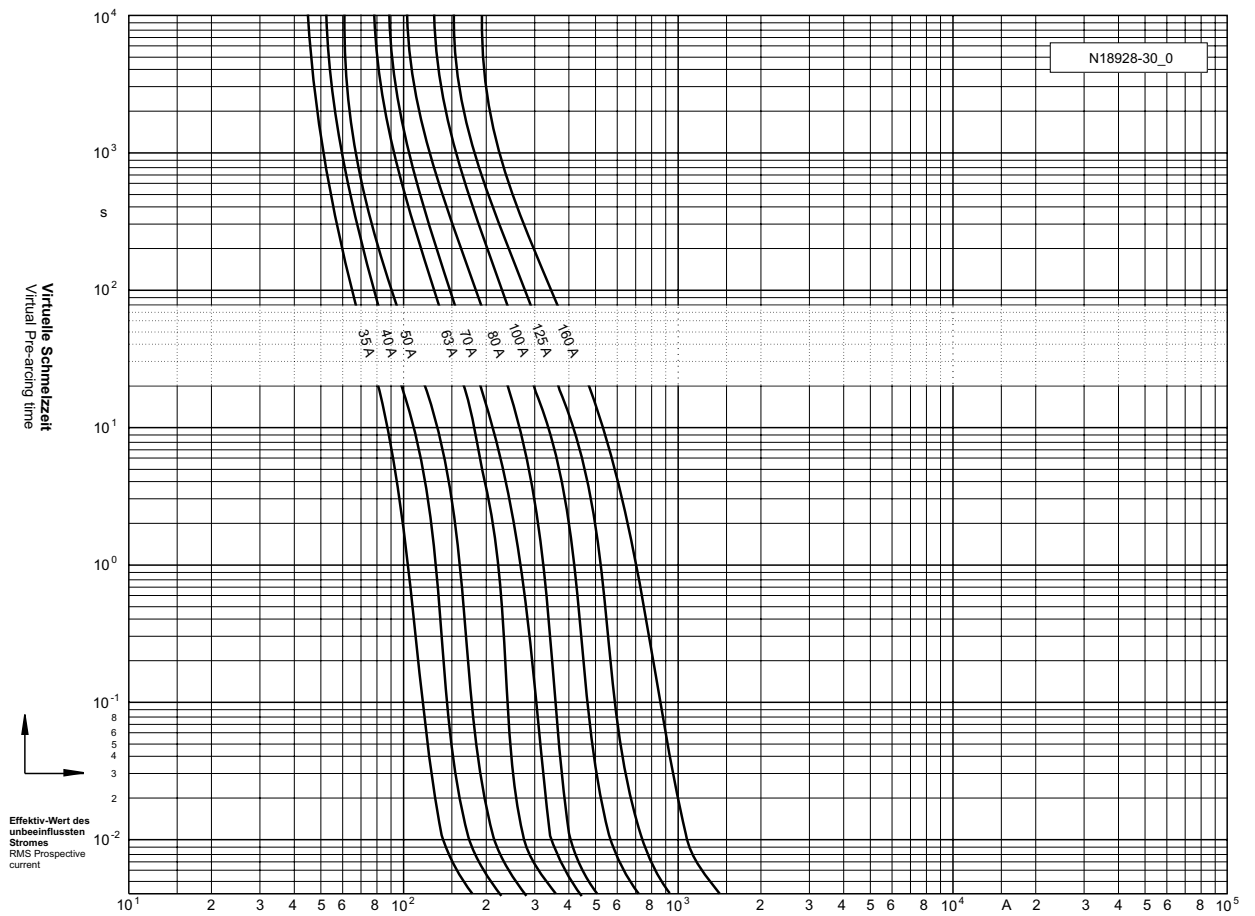

DC 700 V

NH 000 / DIN 80

usE180276

Verpackungseinheit / Packing unit: 6 Stück / 6 pieces

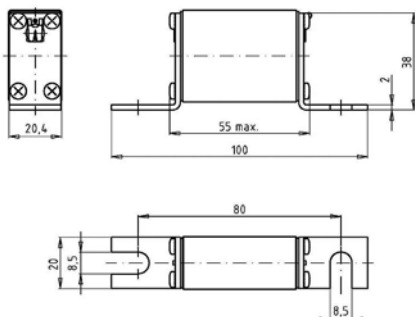

Betriebsklasse / Class
aR

VDE 0636-4
UL 248-13

Bemessungs- spannung Rated Voltage	Artikel Nr. Article No	Größe Size	Bemessungsstrom Rated Current
V			A
DC 700	20 292 20	NH 000 DIN 80	35-315

Bemessungsausschaltvermögen / Rated breaking capacity 30 kA

Bemessungsstrom Rated Current	Artikel Nr. Article No.	Gewicht Weight	Bemessungs- spannung Rated Voltage	Schmelz- integral Pre-Arcing- I ² t-Value	Ausschalt- integral Total I ² t-Value	Leistungs- abgabe Power Loss
	mit Kennmelder with indicator		UL 248-13		@ DC 700 V	
A		kg / l	V	A ² s	A ² s	W
35	20 292 20.35	0,13	DC 700	26	135	14
50	20 292 20.50	0,13	DC 700	104	530	17
63	20 292 20.63	0,13	DC 700	140	690	20
80	20 292 20.80	0,13	DC 700	330	1650	23
100	20 292 20.100	0,13	DC 700	930	4.300	26
125	20 292 20.125	0,13	DC 700	1.400	6.400	30
160	20 292 20.160	0,13	DC 700	1.950	8.800	35
200	20 292 20.200	0,13	DC 700	3.740	16.100	40
250	20 292 20.250	0,13	DC 700	5.580	22.900	45
315	20 292 20.315	0,13	DC 700	12.300	46.000	51

Sicherungshalter siehe Seite 42
Fuse-holder see page 42

Applikationskoeffizienten / Application coefficients (Weiterführende Informationen siehe Seite 13 / for more information see page 13)

a	A2	B1 max.	B2	Cf3
130	0,6	1,25	0,6	0,8

DC 700 V

NH 000 / DIN 80

usE180276

Zeit/Strom-
Kennlinien
Time-current
characteristics

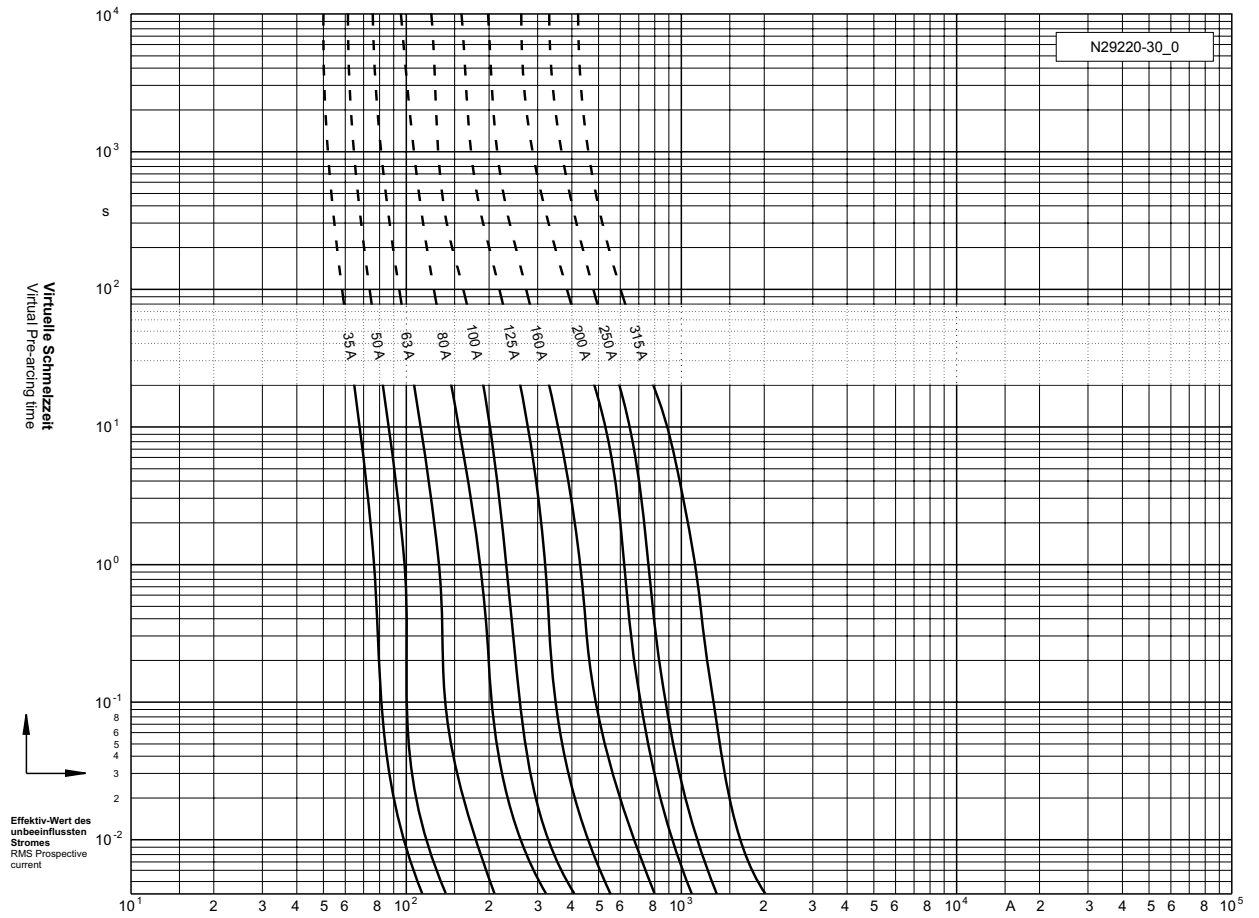

1000 V

Sicherungsunterteil für URB-Sicherungseinsätze NH 00 / DIN 80
Fuse-bases for URB Fuse-links

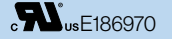

Bemessungs- spannung	Artikel Nr.	Größe	Bemessungsstrom	Max. Leistungsauf- nahme	Anschluß- bolzen	Max. Anzugs- drehmoment (Anschluß- bolzen)	Max. Anzugs- drehmoment (Unterteil)	Kontaktplatte
Rated Voltage	Article No	Size	Rated Current	Rated Power Acceptance	Connection bolts	Max. Nut Torque	Max. Fuse base Torque	Contact plate
V			A	W		Nm	Nm	
1000	21189 01	NH00	400	34	M8 Edelstahl stainless steel	12	4	Kupfer, versilbert copper, silver plated
	21189 08							

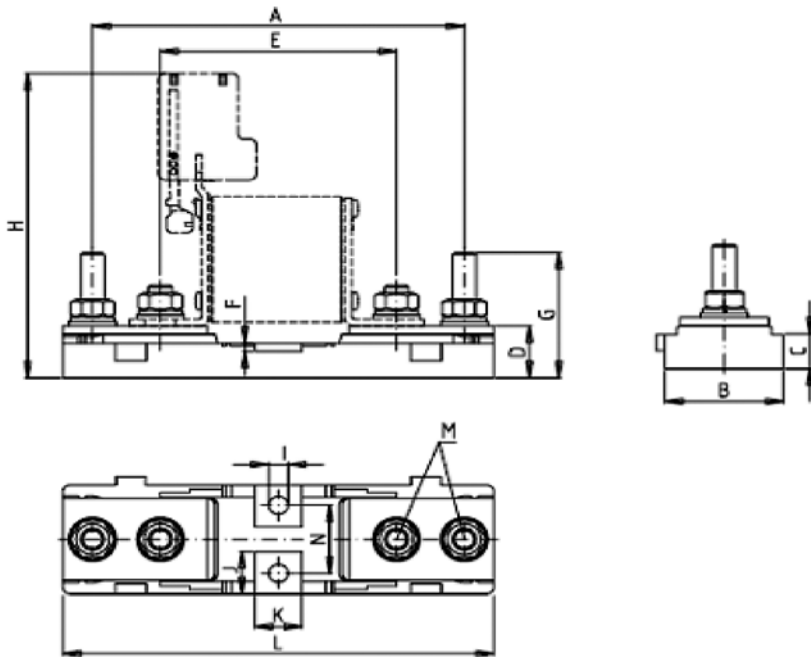

Artikel Nr.	Länge	
Article No.	length	
21 189 01	mm	inch
A	126	4,96"
B	40	1,57"
C	13	0,5"
D	19	0,75"
E	80	3,15"
F	3	0,12"
G	46	1,81"
H	112	4,4"
I	6,5	0,26"
J	15,5	0,6"
K	16	0,63"
L(max)	146	5,75"
M	M8	M8
N	25	0,98"

Artikel Nr.	Verpackungs- einheit	Gewicht
Article No.	Packing unit	Weight
	Stück / pieces	kg / 1
21189 01	5	0,25
21189 08	3	0,26

1000 V

Sicherungsunterteil für URB-Sicherungseinsätze NH 00 / DIN 80
Fuse-bases for URB Fuse-links

 **usE186970**

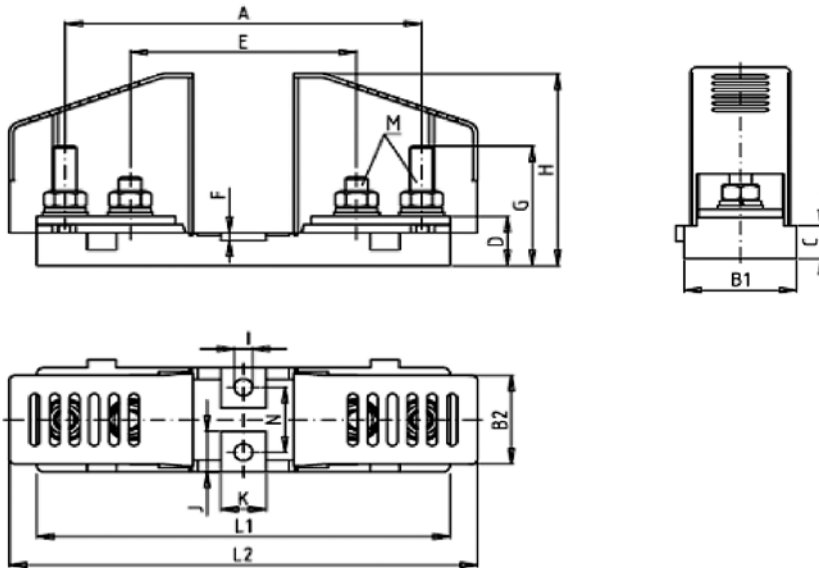

mit Abdeckhauben
with terminalcovers

Artikel Nr.	Länge	
Article No.	length	
21 189 08	mm	inch
A	126	4,96"
B1 max.	40	1,57"
B2	34	1,34"
C	13	0,5"
D	19	0,75"
E	80	3,15"
F	3	0,12"
G	46	1,81"
H	74	2,91"
I	6,5	0,26"
J	15,5	0,6"
K	16	0,63"
L1	146	5,75"
L2	165	6,5"
M	M8	M8
N	25	0,98"

250 V

GL-Meldeschalter für Griffflaschenmontage low level
GL-Switch for gripping lug low level

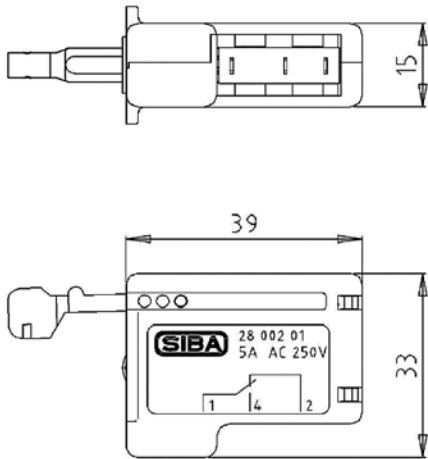

28 002 01

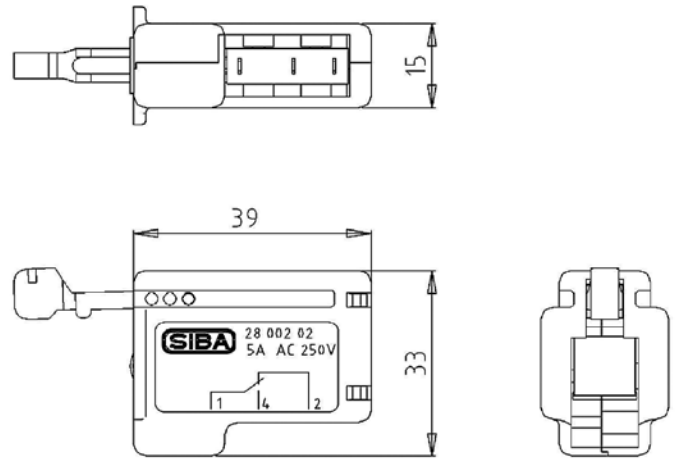

28 002 02

Verpackungseinheit / Packing unit: 10 Stück / 10 pieces

Bemessungsspannung Rated Voltage	Artikel-Nr. Article No.	Gewicht Weight	Bemessungsstrom Rated Current	Anschluss Terminal	Temperaturbereich Temperature range	Flammbarkeitsklasse "UL94" Flammability "UL94"	Wechsler Change over circuit	Verwendbar für Sicherungseinsätze Suitable for following Fuse-links
V		kg / 1	A					
250	28 002 01 Standard	0,02	5	AMP 2.8 x 0,5	-40°C – +80°C	VO	1	NH 00 DIN 80 SQB 1-3
250	28 002 02 Standard	0,02	5	AMP 2.8 x 0,5	-40°C – +80°C	VO	1	NH 000 DIN 80 NH 000-4

Schaltvermögen / Interrupting Rating	
Artikel-Nr. / Article No. 28 002 02	
AC 250 V / 5 A	Ohmsche Last / Non inductive circuit
3 A	Induktive Last / Inductive circuit
DC 33 V / 3 A	Ohmsche Last / Non inductive circuit
DC 26 V / 3 A	Induktive Last (L/R=10 ms) / Inductive circuit (L/R=10 ms)

Maximales Gleichspannungsschaltvermögen
max. DC voltage capability

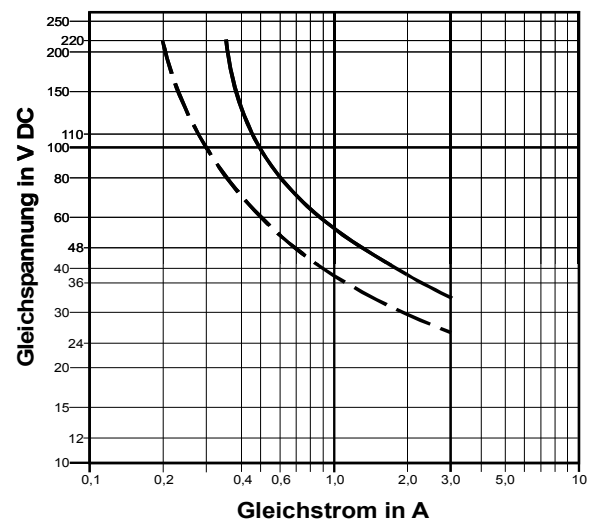

250 V

GL-Meldeschalter für Griffflaschenmontage low level
GL-Switch for gripping lug low level

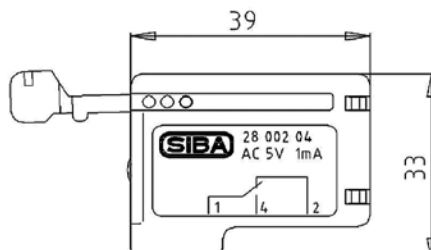
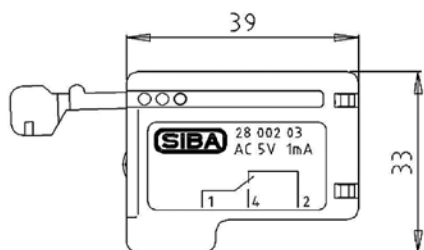
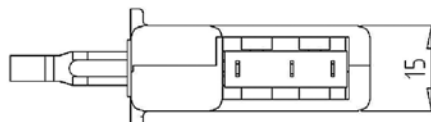
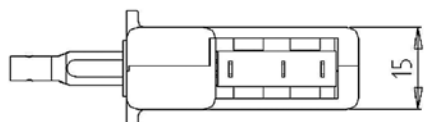

28 002 03

28 002 04

Verpackungseinheit / Packing unit: 10 Stück / 10 pieces

Bemessungsspannung Rated Voltage	Artikel-Nr. Article No.	Gewicht Weight	Bemessungsstrom Rated Current	Anschluss Terminal	Temperaturbereich Temperature range	Flammbarkeitsklasse "UL94" Flammability "UL94"	Wechsler Change over circuit	Verwendbar für Sicherungseinsätze Suitable for following Fuse-links
V		kg / 1	A					
250	28 002 03 low level	0,02	5	AMP 2.8 x 0,5	-40°C – +80°C	VO	1	NH 00 DIN 80 SQB 1-3
250	28 002 04 low level	0,02	5	AMP 2.8 x 0,5	-40°C – +80°C	VO	1	NH 000 DIN 80 NH 000-4

Voltage / Spannung	Schaltvermögen / Interrupting Rating	
	Artikel-Nr. / Article No. 28 002 04	
	Min. Daten / Min. data	Max. Daten / Max. data
AC	5 V Ohmsche Last / Non inductive circuit 1 mA	30 V / 0,3 A
DC	5 V Ohmsche Last / Non inductive circuit 1 mA	30 V / 0,3 A

DC 600 V

**Sicherungsunterteil für gPV-Sicherungseinsätze NH 00 / DIN 80
Fuse-bases for gPV Fuse-links**



IEC 60 269-4 / UL 4248-18

Bemessungsspannung Rated Voltage	Artikel Nr. Article No	Größe Size	Bemessungsstrom Rated Current	Max. Leistungsaufnahme Rated Power Acceptance	Anschlußbolzen Connection bolts	Max. Anzugsdrehmoment (Anschlußbolzen) Max. Nut Torque	Max. Anzugsdrehmoment (Unterteil) Max. Fuse base Torque	Kontaktplatte Contact plate
V			A	W		Nm	Nm	
DC 600 V	21189 28	NH00	200	34	M8 Edelstahl stainless steel	12	4	Kupfer, versilbert copper, silver plated
	21190 28							

Bemessungsausschaltvermögen / Rated breaking capacity 30 kA

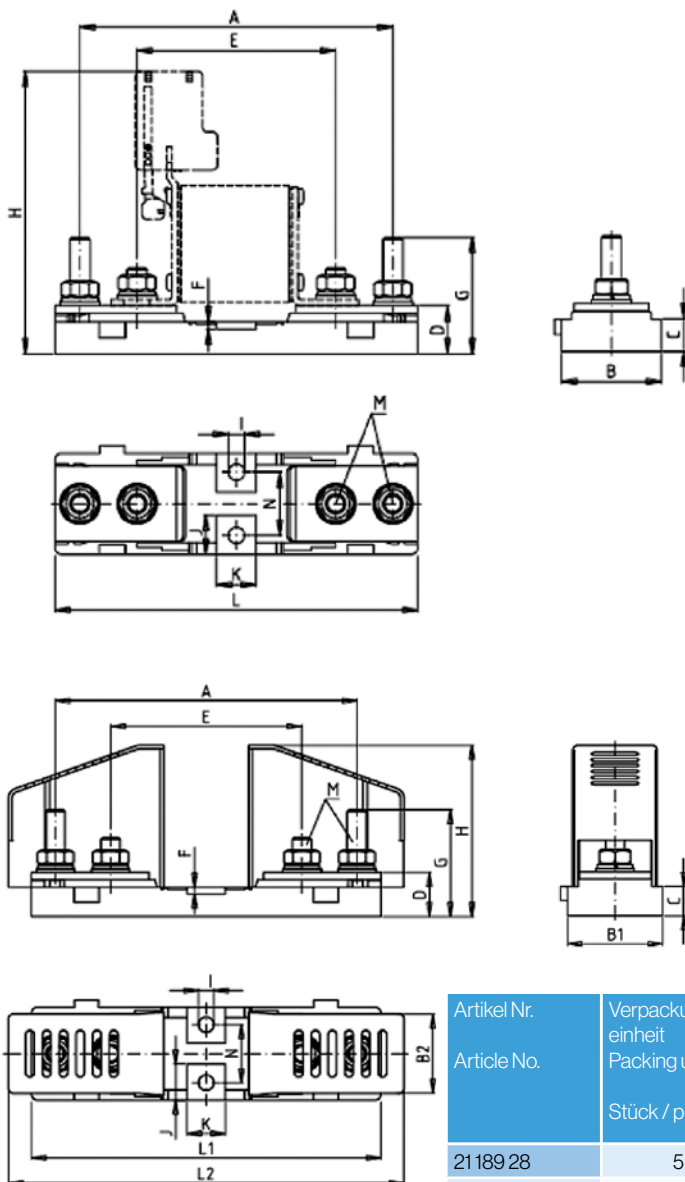

Artikel Nr. Article No.	Verpackungseinheit Packing unit	Gewicht Weight
	Stück / pieces	kg / 1
21189 28	5	0,25
21190 28	3	0,26

Artikel Nr. Article No.	Länge length	
	mm	inch
21 189 28		
A	126	4,96"
B	40	1,57"
C	13	0,50"
D	19	0,75"
E	80	3,15"
F	3	0,12"
G	46	1,81"
H	112	4,40"
I	6,5	0,26"
J	15,5	0,60"
K	16	0,63"
L(max)	146	5,75"
M	M8	M8
N	25	0,98"

Sicherungsunterteil mit Abdeckungen
Fuse-Base with covers

Artikel Nr. Article No.	Länge length	
	mm	inch
21190 28		
A	126	4,96"
B1 max.	40	1,57"
B2	34	1,34"
C	13	0,5"
D	19	0,75"
E	80	3,15"
F	3	0,12"
G	46	1,81"
H	74	2,91"
I	6,5	0,26"
J	15,5	0,6"
K	16	0,63"
L1	146	5,75"
L2	165	6,5"
M	M8	M8
N	25	0,98"